

## **Appendix 15. In-Stream Permits and Notification Forms**



## Appendix 15. In-Stream Permits and Notification Forms

### US Army Corps of Engineers Nationwide Permit (NWP) General Conditions

- 1. Navigation.** No activity may cause more than a minimal adverse effect on navigation.
- 2. Proper Maintenance.** Any structure or fill authorized shall be properly maintained, including maintenance to ensure public safety.
- 3. Soil Erosion and Sediment Controls.** Appropriate soil erosion and sediment controls must be used and maintained in effective operating condition during construction, and all exposed soil and other fills, as well as any work below the ordinary high water mark or high tide line, must be permanently stabilized at the earliest practicable date. Permittees are encouraged to perform work within waters of the United States during periods of low-flow or no-flow.
- 4. Aquatic Life Movements.** No activity may substantially disrupt the necessary life-cycle movements of those species of aquatic life indigenous to the waterbody, including those species that normally migrate through the area, unless the activity's primary purpose is to impound water. Culverts placed in streams must be installed to maintain low flow conditions.
- 5. Equipment.** Heavy equipment working in wetlands must be placed on mats, or other measures must be taken to minimize soil disturbance.
- 6. Regional and Case-By-Case Conditions.** The activity must comply with any regional conditions that may have been added by the Division Engineer (see 33 CFR 330.4(e)) and with any case specific conditions added by the Corps or by the state or tribe in its Section 401 Water Quality Certification and Coastal Zone Management Act consistency determination.
- 7. Wild and Scenic Rivers.** No activity may occur in a component of the National Wild and Scenic River System; or in a river officially designated by Congress as a "study river" for possible inclusion in the system, while the river is in an official study status; unless the appropriate Federal agency, with direct management responsibility for such river, has determined in writing that the proposed activity will not adversely affect the Wild and Scenic River designation, or study status. Information on Wild and Scenic Rivers may be obtained from the appropriate Federal land management agency in the area (e.g., National Park Service, U.S. Forest Service, Bureau of Land Management, U.S. Fish and Wildlife Service).
- 8. Tribal Rights.** No activity or its operation may impair reserved tribal rights, including, but not limited to, reserved water rights and treaty fishing and hunting rights.
- 9. Water Quality.** (a) In certain states and tribal lands an individual 401 Water Quality Certification must be obtained or waived (See 33 CFR 330.4(c)).  
(b) For NWPs 12, 14, 17, 18, 32, 39, 40, 42, 43, and 44, where the state or tribal 401 certification (either generically or individually) does not require or approve water quality management measures, the permittee must provide water quality management measures that will ensure that the authorized work does not result in more than minimal degradation of water quality (or the Corps determines that compliance with state or local standards, where applicable, will ensure no more than minimal adverse effect on water quality). An important component of

water quality management includes stormwater management that minimizes degradation of the downstream aquatic system, including water quality (refer to General Condition 21 for stormwater management requirements). Another important component of water quality management is the establishment and maintenance of vegetated buffers next to open waters, including streams (refer to General Condition 19 for vegetated buffer requirements for the NWP).

This condition is only applicable to projects that have the potential to affect water quality. While appropriate measures must be taken, in most cases it is not necessary to conduct detailed studies to identify such measures or to require monitoring.

**10. Coastal Zone Management.** In certain states, an individual state coastal zone management consistency concurrence must be obtained or waived (see 33 CFR 330.4(d)).

**11. Endangered Species.** (a) No activity is authorized under any NWP which is likely to jeopardize the continued existence of a threatened or endangered species or a species proposed for such designation, as identified under the Federal Endangered Species Act (ESA), or which will destroy or adversely modify the critical habitat of such species. Non-federal permittees shall notify the District Engineer if any listed species or designated critical habitat might be affected or is in the vicinity of the project, or is located in the designated critical habitat and shall not begin work on the activity until notified by the District Engineer that the requirements of the ESA have been satisfied and that the activity is authorized. For activities that may affect Federally-listed endangered or threatened species or designated critical habitat, the notification must include the name(s) of the endangered or threatened species that may be affected by the proposed work or that utilize the designated critical habitat that may be affected by the proposed work. As a result of formal or informal consultation with the FWS or NMFS the District Engineer may add species-specific regional endangered species conditions to the NWPs.

(b) Authorization of an activity by a NWP does not authorize the “take” of a threatened or endangered species as defined under the ESA. In the absence of separate authorization (e.g., an ESA Section 10 Permit, a Biological Opinion with “incidental take” provisions, etc.) from the USFWS or the NMFS, both lethal and non-lethal “takes” of protected species are in violation of the ESA. Information on the location of threatened and endangered species and their critical habitat can be obtained directly from the offices of the USFWS and NMFS or their world wide web pages at <http://www.fws.gov/r9endspp/endspp.html> and [http://www.nfms.noaa.gov/prot\\_res/overview/es.html](http://www.nfms.noaa.gov/prot_res/overview/es.html) respectively.

**12. Historic Properties.** No activity which may affect historic properties listed, or eligible for listing, in the National Register of Historic Places is authorized, until the District Engineer has complied with the provisions of 33 CFR part 325, Appendix C. The prospective permittee must notify the District Engineer if the authorized activity may affect any historic properties listed, determined to be eligible, or which the prospective permittee has reason to believe may be eligible for listing on the National Register of Historic Places, and shall not begin the activity until notified by the District Engineer that the requirements of the National Historic Preservation Act have been satisfied and that the activity is authorized. Information on the location and existence of historic resources can be obtained from the State Historic Preservation Office and the National Register of Historic Places (see 33 CFR 330.4(g)). For activities that may affect historic properties listed in, or eligible for listing in, the National Register of Historic

Places, the notification must state which historic property may be affected by the proposed work or include a vicinity map indicating the location of the historic property.

**13. Notification.** (a) Timing; where required by the terms of the NWP, the prospective permittee must notify the District Engineer with a preconstruction notification (PCN) as early as possible. The District Engineer must determine if the notification is complete within 30 days of the date of receipt and can request additional information necessary to make the PCN complete only once. However, if the prospective permittee does not provide all of the requested information, then the District Engineer will notify the prospective permittee that the notification is still incomplete and the PCN review process will not commence until all of the requested information has been received by the District Engineer. The prospective permittee shall not begin the activity:

(1) Until notified in writing by the District Engineer that the activity may proceed under the NWP with any special conditions imposed by the District or Division Engineer; or

(2) If notified in writing by the District or Division Engineer that an Individual Permit is required; or

(3) Unless 45 days have passed from the District Engineer's receipt of the complete notification and the prospective permittee has not received written notice from the District or Division Engineer. Subsequently, the permittee's right to proceed under the NWP may be modified, suspended, or revoked only in accordance with the procedure set forth in 33 CFR 330.5(d)(2).

(b) Contents of Notification: The notification must be in writing and include the following information:

(1) Name, address and telephone numbers of the prospective permittee;

(2) Location of the proposed project;

(3) Brief description of the proposed project; the project's purpose; direct and indirect adverse environmental effects the project would cause; any other NWP(s), Regional General Permit(s), or Individual Permit(s) used or intended to be used to authorize any part of the proposed project or any related activity. Sketches should be provided when necessary to show that the activity complies with the terms of the NWP (Sketches usually clarify the project and when provided result in a quicker decision.);

(4) For NWPs 7, 12, 14, 18, 21, 34, 38, 39, 40, 41, 42, and 43, the PCN must also include a delineation of affected special aquatic sites, including wetlands, vegetated shallows (e.g., submerged aquatic vegetation, seagrass beds), and riffle and pool complexes (see paragraph 13(f));

(5) For NWP 7 (Outfall Structures and Maintenance), the PCN must include information regarding the original design capacities and configurations of those areas of the facility where maintenance dredging or excavation is proposed;

(6) For NWP 14 (Linear Transportation Projects), the PCN must include a compensatory mitigation proposal to offset permanent losses of waters of the US and a statement describing how temporary losses of waters of the US will be minimized to the maximum extent practicable;

(7) For NWP 21 (Surface Coal Mining Activities), the PCN must include an Office of Surface Mining (OSM) or state-approved mitigation plan, if applicable. To be authorized by this NWP, the District Engineer must determine that the activity complies with the terms and conditions of the NWP and that the adverse environmental effects are minimal both individually and cumulatively and must notify the project sponsor of this determination in writing;

(8) For NWP 27 (Stream and Wetland Restoration Activities), the PCN must include documentation of the prior condition of the site that will be reverted by the permittee;

(9) For NWP 29 (Single-Family Housing), the PCN must also include:

(i) Any past use of this NWP by the Individual Permittee and/or the permittee's spouse;

(ii) A statement that the single-family housing activity is for a personal residence of the permittee;

(iii) A description of the entire parcel, including its size, and a delineation of wetlands.

For the purpose of this NWP, parcels of land measuring 1/4-acre or less will not require a formal on-site delineation. However, the applicant shall provide an indication of where the wetlands are and the amount of wetlands that exists on the property. For parcels greater than 1/4-acre in size, a formal wetland delineation must be prepared in accordance with the current method required by the Corps. (See paragraph 13(f));

(iv) A written description of all land (including, if available, legal descriptions) owned by the prospective permittee and/or the prospective permittee's spouse, within a one mile radius of the parcel, in any form of ownership (including any land owned as a partner, corporation, joint tenant, co-tenant, or as a tenant-by-the-entirety) and any land on which a purchase and sale agreement or other contract for sale or purchase has been executed;

(10) For NWP 31 (Maintenance of Existing Flood Control Facilities), the prospective permittee must either notify the District Engineer with a PCN prior to each maintenance activity or submit a five year (or less) maintenance plan. In addition, the PCN must include all of the following:

(i) Sufficient baseline information identifying the approved channel depths and configurations and existing facilities. Minor deviations are authorized, provided the approved flood control protection or drainage is not increased;

(ii) A delineation of any affected special aquatic sites, including wetlands; and,

(iii) Location of the dredged material disposal site;

(11) For NWP 33 (Temporary Construction, Access, and Dewatering), the PCN must also include a restoration plan of reasonable measures to avoid and minimize adverse effects to aquatic resources;

(12) For NWPs 39, 43 and 44, the PCN must also include a written statement to the District Engineer explaining how avoidance and minimization for losses of waters of the US were achieved on the project site;

(13) For NWP 39 and NWP 42, the PCN must include a compensatory mitigation proposal to offset losses of waters of the US or justification explaining why compensatory mitigation should not be required. For discharges that cause the loss of greater than 300 linear feet of an intermittent stream bed, to be authorized, the District Engineer must determine that the activity complies with the other terms and conditions of the NWP, determine adverse environmental effects are minimal both individually and cumulatively, and waive the limitation on stream impacts in writing before the permittee may proceed;

(14) For NWP 40 (Agricultural Activities), the PCN must include a compensatory mitigation proposal to offset losses of waters of the US. This NWP does not authorize the relocation of greater than 300 linear-feet of existing serviceable drainage ditches constructed in non-tidal streams unless, for drainage ditches constructed in intermittent non-tidal streams, the District Engineer waives this criterion in writing, and the District Engineer has determined that the project complies with all terms and conditions of this NWP, and that any adverse impacts of the project on the aquatic environment are minimal, both individually and cumulatively;

(15) For NWP 43 (Stormwater Management Facilities), the PCN must include, for the construction of new stormwater management facilities, a maintenance plan (in accordance with state and local requirements, if applicable) and a compensatory mitigation proposal to offset losses of waters of the US. For discharges that cause the loss of greater than 300 linear feet of an intermittent stream bed, to be authorized, the District Engineer must determine that the activity complies with the other terms and conditions of the NWP, determine adverse environmental effects are minimal both individually and cumulatively, and waive the limitation on stream impacts in writing before the permittee may proceed;

(16) For NWP 44 (Mining Activities), the PCN must include a description of all waters of the US adversely affected by the project, a description of measures taken to minimize adverse effects to waters of the US, a description of measures taken to comply with the criteria of the NWP, and a reclamation plan (for all aggregate mining activities in isolated waters and non-tidal wetlands adjacent to headwaters and any hard rock/mineral mining activities);

(17) For activities that may adversely affect Federally-listed endangered or threatened species, the PCN must include the name(s) of those endangered or threatened species that may be affected by the proposed work or utilize the designated critical habitat that may be affected by the proposed work; and

(18) For activities that may affect historic properties listed in, or eligible for listing in, the National Register of Historic Places, the PCN must state which historic property may be affected by the proposed work or include a vicinity map indicating the location of the historic property.

(c) Form of Notification: The standard Individual Permit application form (Form ENG 4345) may be used as the notification but must clearly indicate that it is a PCN and must include all of the information required in (b) (1)-(18) of General Condition 13. A letter containing the requisite information may also be used.

(d) District Engineer's Decision: In reviewing the PCN for the proposed activity, the District Engineer will determine whether the activity authorized by the NWP will result in more than minimal individual or cumulative adverse environmental effects or may be contrary to the public interest. The prospective permittee may submit a proposed mitigation plan with the PCN to expedite the process. The District Engineer will consider any proposed compensatory mitigation the applicant has included in the proposal in determining whether the net adverse environmental effects to the aquatic environment of the proposed work are minimal. If the District Engineer determines that the activity complies with the terms and conditions of the NWP and that the adverse effects on the aquatic environment are minimal, after considering mitigation, the District Engineer will notify the permittee and include any conditions the District Engineer deems necessary. The District Engineer must approve any compensatory mitigation proposal before the permittee commences work. If the prospective permittee is required to submit a compensatory mitigation proposal with the PCN, the proposal may be either conceptual or detailed. If the prospective permittee elects to submit a compensatory mitigation plan with the PCN, the District Engineer will expeditiously review the proposed compensatory mitigation plan. The District Engineer must review the plan within 45 days of receiving a complete PCN and determine whether the conceptual or specific proposed mitigation would ensure no more than minimal adverse effects on the aquatic environment. If the net adverse effects of the project on the aquatic environment (after consideration of the compensatory mitigation proposal) are determined by the District Engineer to be minimal, the District Engineer will provide a timely written response to the applicant. The response will state that the project can proceed under the terms and conditions of the NWP.

If the District Engineer determines that the adverse effects of the proposed work are more than minimal, then the District Engineer will notify the applicant either: (1) That the project does not qualify for authorization under the NWP and instruct the applicant on the procedures to seek authorization under an Individual Permit; (2) that the project is authorized under the NWP subject to the applicant's submission of a mitigation proposal that would reduce the adverse effects on the aquatic environment to the minimal level; or (3) that the project is authorized under the NWP with specific modifications or conditions. Where the District Engineer determines that mitigation is required to ensure no more than minimal adverse effects occur to the aquatic environment, the activity will be authorized within the 45-day PCN period. The authorization will include the necessary conceptual or specific mitigation or a requirement that the applicant submit a mitigation proposal that would reduce the adverse effects on the aquatic environment to the minimal level. When conceptual mitigation is included, or a mitigation plan is required under item (2) above, no work in waters of the US will occur until the District Engineer has approved a specific mitigation plan.

(e) Agency Coordination: The District Engineer will consider any comments from Federal and state agencies concerning the proposed activity's compliance with the terms and conditions of the NWPs and the need for mitigation to reduce the project's adverse environmental effects to a minimal level.

For activities requiring notification to the District Engineer that result in the loss of greater than 1/2-acre of waters of the US, the District Engineer will provide immediately (e.g., via facsimile transmission, overnight mail, or other expeditious manner) a copy to the appropriate Federal or state offices (USFWS, state natural resource or water quality agency, EPA, State Historic Preservation Officer (SHPO), and, if appropriate, the NMFS). With the exception of NWP 37, these agencies will then have 10 calendar days from the date the material is transmitted to telephone or fax the District Engineer notice that they intend to provide substantive, site-specific comments. If so contacted by an agency, the District Engineer will wait an additional 15 calendar days before making a decision on the notification. The District Engineer will fully consider agency comments received within the specified time frame, but will provide no response to the resource agency, except as provided below. The District Engineer will indicate in the administrative record associated with each notification that the resource agencies' concerns were considered. As required by section 305(b)(4)(B) of the Magnuson-Stevens Fishery Conservation and Management Act, the District Engineer will provide a response to NMFS within 30 days of receipt of any Essential Fish Habitat conservation recommendations. Applicants are encouraged to provide the Corps multiple copies of notifications to expedite agency notification.

(f) Wetland Delineations: Wetland delineations must be prepared in accordance with the current method required by the Corps (For NWP 29 see paragraph (b)(9)(iii) for parcels less than (1/4-acre in size). The permittee may ask the Corps to delineate the special aquatic site. There may be some delay if the Corps does the delineation. Furthermore, the 45-day period will not start until the wetland delineation has been completed and submitted to the Corps, where appropriate.



**14. Compliance Certification.** Every permittee who has received NWP verification from the Corps will submit a signed certification regarding the completed work and any required mitigation. The certification will be forwarded by the Corps with the authorization letter and will include:

- (a) A statement that the authorized work was done in accordance with the Corps authorization, including any general or specific conditions;
- (b) A statement that any required mitigation was completed in accordance with the permit conditions; and
- (c) The signature of the permittee certifying the completion of the work and mitigation.

**15. Use of Multiple Nationwide Permits.** The use of more than one NWP for a single and complete project is prohibited, except when the acreage loss of waters of the US authorized by the NWPs does not exceed the acreage limit of the NWP with the highest specified acreage limit (e.g. if a road crossing over tidal waters is constructed under NWP 14, with associated bank stabilization authorized by NWP 13, the maximum acreage loss of waters of the US for the total project cannot exceed 1/3-acre).

**16. Water Supply Intakes.** No activity, including structures and work in navigable waters of the US or discharges of dredged or fill material, may occur in the proximity of a public water supply intake except where the activity is for repair of the public water supply intake structures or adjacent bank stabilization.

**17. Shellfish Beds.** No activity, including structures and work in navigable waters of the US or discharges of dredged or fill material, may occur in areas of concentrated shellfish populations, unless the activity is directly related to a shellfish harvesting activity authorized by NWP 4.

**18. Suitable Material.** No activity, including structures and work in navigable waters of the US or discharges of dredged or fill material, may consist of unsuitable material (e.g., trash, debris, car bodies, asphalt, etc.) and material used for construction or discharged must be free from toxic pollutants in toxic amounts (see section 307 of the CWA).

**19. Mitigation.** The District Engineer will consider the factors discussed below when determining the acceptability of appropriate and practicable mitigation necessary to offset adverse effects on the aquatic environment that are more than minimal.

(a) The project must be designed and constructed to avoid and minimize adverse effects to waters of the US to the maximum extent practicable at the project site (i.e., on site).

(b) Mitigation in all its forms (avoiding, minimizing, rectifying, reducing or compensating) will be required to the extent necessary to ensure that the adverse effects to the aquatic environment are minimal.

(c) Compensatory mitigation at a minimum one-for-one ratio will be required for all wetland impacts requiring a PCN, unless the District Engineer determines in writing that some other form of mitigation would be more environmentally appropriate and provides a project-specific waiver of this requirement. Consistent with National policy, the District Engineer will establish a preference for restoration of wetlands as compensatory mitigation, with preservation used only in exceptional circumstances.

(d) Compensatory mitigation (i.e., replacement or substitution of aquatic resources for those impacted) will not be used to increase the acreage losses allowed by the acreage limits of some of the NWP. For example, 1/4-acre of wetlands cannot be created to change a 3/4-acre loss of wetlands to a 1/2-acre loss associated with NWP 39 verification. However, 1/2-acre of created wetlands can be used to reduce the impacts of a 1/2-acre loss of wetlands to the minimum impact level in order to meet the minimal impact requirement associated with NWPs.

(e) To be practicable, the mitigation must be available and capable of being done considering costs, existing technology, and logistics in light of the overall project purposes. Examples of mitigation that may be appropriate and practicable include, but are not limited to: reducing the size of the project; establishing and maintaining wetland or upland vegetated buffers to protect open waters such as streams; and replacing losses of aquatic resource functions and values by creating, restoring, enhancing, or preserving similar functions and values, preferably in the same watershed.

(f) Compensatory mitigation plans for projects in or near streams or other open waters will normally include a requirement for the establishment, maintenance, and legal protection (e.g., easements, deed restrictions) of vegetated buffers to open waters. In many cases, vegetated buffers will be the only compensatory mitigation required. Vegetated buffers should consist of native species. The width of the vegetated buffers required will address documented water quality or aquatic habitat loss concerns. Normally, the vegetated buffer will be 25 to 50 feet wide on each side of the stream, but the District Engineers may require slightly wider vegetated buffers to address documented water quality or habitat loss concerns. Where both wetlands and open waters exist on the project site, the Corps will determine the appropriate compensatory mitigation (e.g., stream buffers or wetlands compensation) based on what is best for the aquatic environment on a watershed basis. In cases where vegetated buffers are determined to be the most appropriate form of compensatory mitigation, the District Engineer may waive or reduce the requirement to provide wetland compensatory mitigation for wetland impacts.

(g) Compensatory mitigation proposals submitted with the “notification” may be either conceptual or detailed. If conceptual plans are approved under the verification, then the Corps will condition the verification to require detailed plans be submitted and approved by the Corps prior to construction of the authorized activity in waters of the U.S.

(h) Permittees may propose the use of mitigation banks, in-lieu fee arrangements or separate activity-specific compensatory mitigation. In all cases that require compensatory mitigation, the mitigation provisions will specify the party responsible for accomplishing and/or complying with the mitigation plan.

**20. Spawning Areas.** Activities, including structures and work in navigable waters of the US or discharges of dredged or fill material, in spawning areas during spawning seasons must be avoided to the maximum extent practicable. Activities that result in the physical destruction (e.g., excavate, fill, or smother downstream by substantial turbidity) of an important spawning area are not authorized.

**21. Management of Water Flows.** To the maximum extent practicable, the activity must be designed to maintain preconstruction downstream flow conditions (e.g., location, capacity, and flow rates). Furthermore, the activity must not permanently restrict or impede the passage of normal or expected high flows (unless the primary purpose of the fill is to impound waters) and the structure or discharge of dredged or fill material must withstand expected high flows. The

activity must, to the maximum extent practicable, provide for retaining excess flows from the site, provide for maintaining surface flow rates from the site similar to preconstruction conditions, and provide for not increasing water flows from the project site, relocating water, or redirecting water flow beyond preconstruction conditions. Stream channelizing will be reduced to the minimal amount necessary, and the activity must, to the maximum extent practicable, reduce adverse effects such as flooding or erosion downstream and upstream of the project site, unless the activity is part of a larger system designed to manage water flows. In most cases, it will not be a requirement to conduct detailed studies and monitoring of water flow.

This condition is only applicable to projects that have the potential to affect waterflows. While appropriate measures must be taken, it is not necessary to conduct detailed studies to identify such measures or require monitoring to ensure their effectiveness. Normally, the Corps will defer to state and local authorities regarding management of water flow.

**22. Adverse Effects From Impoundments.** If the activity creates an impoundment of water, adverse effects to the aquatic system due to the acceleration of the passage of water, and/or the restricting its flow shall be minimized to the maximum extent practicable. This includes structures and work in navigable waters of the US, or discharges of dredged or fill material.

**23. Waterfowl Breeding Areas.** Activities, including structures and work in navigable waters of the US or discharges of dredged or fill material, into breeding areas for migratory waterfowl must be avoided to the maximum extent practicable.

**24. Removal of Temporary Fills.** Any temporary fills must be removed in their entirety and the affected areas returned to their preexisting elevation.

**25. Designated Critical Resource Waters.** Critical resource waters include, NOAA-designated marine sanctuaries, National Estuarine Research Reserves, National Wild and Scenic Rivers, critical habitat for Federally listed threatened and endangered species, coral reefs, state natural heritage sites, and outstanding national resource waters or other waters officially designated by a state as having particular environmental or ecological significance and identified by the District Engineer after notice and opportunity for public comment. The District Engineer may also designate additional critical resource waters after notice and opportunity for comment.

(a) Except as noted below, discharges of dredged or fill material into waters of the US are not authorized by NWPs 7, 12, 14, 16, 17, 21, 29, 31, 35, 39, 40, 42, 43, and 44 for any activity within, or directly affecting, critical resource waters, including wetlands adjacent to such waters. Discharges of dredged or fill materials into waters of the US may be authorized by the above NWPs in National Wild and Scenic Rivers if the activity complies with General Condition 7. Further, such discharges may be authorized in designated critical habitat for Federally listed threatened or endangered species if the activity complies with General Condition 11 and the USFWS or the NMFS has concurred in a determination of compliance with this condition.

(b) For NWPs 3, 8, 10, 13, 15, 18, 19, 22, 23, 25, 27, 28, 30, 33, 34, 36, 37, and 38, notification is required in accordance with General Condition 13, for any activity proposed in the designated critical resource waters including wetlands adjacent to those waters. The District Engineer may authorize activities under these NWPs only after it is determined that the impacts to the critical resource waters will be no more than minimal.

**26. Fills Within 100-Year Floodplains.** For purposes of this General Condition, 100-year floodplains will be identified through the existing Federal Emergency Management Agency's (FEMA) Flood Insurance Rate Maps or FEMA-approved local floodplain maps.

(a) Discharges in Floodplain; Below Headwaters. Discharges of dredged or fill material into waters of the US within the mapped 100-year floodplain, below headwaters (i.e. five cfs), resulting in permanent above-grade fills, are not authorized by NWPs 39, 40, 42, 43, and 44.

(b) Discharges in Floodway; Above Headwaters. Discharges of dredged or fill material into waters of the US within the FEMA or locally mapped floodway, resulting in permanent above-grade fills, are not authorized by NWPs 39, 40, 42, and 44.

(c) The permittee must comply with any applicable FEMA-approved state or local floodplain management requirements.

**27. Construction Period.** For activities that have not been verified by the Corps and the project was commenced or under contract to commence by the expiration date of the NWP (or modification or revocation date), the work must be completed within 12-months after such date (including any modification that affects the project).

For activities that have been verified and the project was commenced or under contract to commence within the verification period, the work must be completed by the date determined by the Corps.

For projects that have been verified by the Corps, an extension of a Corps approved completion date maybe requested. This request must be submitted at least one month before the previously approved completion date.

## **Text of 2002 Nationwide Permit Numbers 3(i), 3(ii), 13, 18, 19, 33**

**3. Maintenance.** Activities related to: (i) The repair, rehabilitation, or replacement of any previously authorized, currently serviceable, structure, or fill, or of any currently serviceable structure or fill authorized by 33 CFR 330.3, provided that the structure or fill is not to be put to uses differing from those uses specified or contemplated for it in the original permit or the most recently authorized modification. Minor deviations in the structure's configuration or filled area including those due to changes in materials, construction techniques, or current construction codes or safety standards which are necessary to make repair, rehabilitation, or replacement are permitted, provided the adverse environmental effects resulting from such repair, rehabilitation, or replacement are minimal. Currently serviceable means useable as is or with some maintenance, but not so degraded as to essentially require reconstruction. This NWP authorizes the repair, rehabilitation, or replacement of those structures or fills destroyed or damaged by storms, floods, fire or other discrete events, provided the repair, rehabilitation, or replacement is commenced, or is under contract to commence, within two years of the date of their destruction or damage. In cases of catastrophic events, such as hurricanes or tornadoes, this two-year limit may be waived by the District Engineer, provided the permittee can demonstrate funding, contract, or other similar delays.

(ii) Discharges of dredged or fill material, including excavation, into all waters of the US to remove accumulated sediments and debris in the vicinity of, and within, existing structures (e.g., bridges, culverted road crossings, water intake structures, etc.) and the placement of new or additional riprap to protect the structure, provided the permittee notifies the District Engineer in accordance with General Condition 13. The removal of sediment is limited to the minimum necessary to restore the waterway in the immediate vicinity of the structure to the approximate dimensions that existed when the structure was built, but cannot extend further than 200 feet in any direction from the structure. The placement of rip rap must be the minimum necessary to protect the structure or to ensure the safety of the structure. All excavated materials must be deposited and retained in an upland area unless otherwise specifically approved by the District Engineer under separate authorization. Any bank stabilization measures not directly associated with the structure will require a separate authorization from the District Engineer.

(iii) Discharges of dredged or fill material, including excavation, into all waters of the US for activities associated with the restoration of upland areas damaged by a storm, flood, or other discrete event, including the construction, placement, or installation of upland protection structures and minor dredging to remove obstructions in a water of the US. (Uplands lost as a result of a storm, flood, or other discrete event can be replaced without a Section 404 permit provided the uplands are restored to their original pre-event location. This NWP is for the activities in waters of the US associated with the replacement of the uplands.) The permittee must notify the District Engineer, in accordance with General Condition 13, within 12-months of the date of the damage and the work must commence, or be under contract to commence, within two years of the date of the damage. The permittee should provide evidence, such as a recent topographic survey or photographs, to justify the extent of the proposed restoration. The restoration of the damaged areas cannot exceed the contours, or ordinary high water mark, that existed before the damage. The District Engineer retains the right to determine the extent of the pre-existing conditions and the extent of any restoration work authorized by this permit. Minor dredging to remove obstructions from the adjacent waterbody is limited to 50 cubic yards below the plane of the ordinary high water mark, and is limited to the amount necessary to restore the

pre-existing bottom contours of the waterbody. The dredging may not be done primarily to obtain fill for any restoration activities. The discharge of dredged or fill material and all related work needed to restore the upland must be part of a single and complete project. This permit cannot be used in conjunction with NWP 18 or NWP 19 to restore damaged upland areas. This permit cannot be used to reclaim historic lands lost, over an extended period, to normal erosion processes.

This permit does not authorize maintenance dredging for the primary purpose of navigation and beach restoration. This permit does not authorize new stream channelization or stream relocation projects. Any work authorized by this permit must not cause more than minimal degradation of water quality, more than minimal changes to the flow characteristics of the stream, or increase flooding (See General Conditions 9 and 21). (Sections 10 and 404)

Note: This NWP authorizes the repair, rehabilitation, or replacement of any previously authorized structure or fill that does not qualify for the Section 404(f) exemption for maintenance.

**13. Bank Stabilization.** Bank stabilization activities necessary for erosion prevention provided the activity meets all of the following criteria:

- a. No material is placed in excess of the minimum needed for erosion protection;
- b. The bank stabilization activity is less than 500 feet in length;
- c. The activity will not exceed an average of one cubic yard per running foot placed along the bank below the plane of the ordinary high water mark or the high tide line;
- d. No material is placed in any special aquatic site, including wetlands;
- e. No material is of the type, or is placed in any location, or in any manner, to impair surface water flow into or out of any wetland area;
- f. No material is placed in a manner that will be eroded by normal or expected high flows (properly anchored trees and treetops may be used in low energy areas); and,
- g. The activity is part of a single and complete project.

Bank stabilization activities in excess of 500 feet in length or greater than an average of one cubic yard per running foot may be authorized if the permittee notifies the District Engineer in accordance with the "Notification" General Condition 13 and the District Engineer determines the activity complies with the other terms and conditions of the NWP and the adverse environmental effects are minimal both individually and cumulatively. This NWP may not be used for the channelization of waters of the US. (Sections 10 and 404)

**18. Minor Discharges.** Minor discharges of dredged or fill material into all waters of the US if the activity meets all of the following criteria:

- a. The quantity of discharged material and the volume of area excavated do not exceed 25 cubic yards below the plane of the ordinary high water mark or the high tide line;
- b. The discharge, including any excavated area, will not cause the loss of more than 1/10-acre of a special aquatic site, including wetlands. For the purposes of this NWP, the acreage limitation includes the filled area and excavated area plus special aquatic sites that are adversely affected by flooding and special aquatic sites that are drained so that they would no longer be a water of the US as a result of the project;
- c. If the discharge, including any excavated area, exceeds 10 cubic yards below the plane of the ordinary high water mark or the high tide line or if the discharge is in a special aquatic

site, including wetlands, the permittee notifies the District Engineer in accordance with the “Notification” General Condition. For discharges in special aquatic sites, including wetlands, the notification must also include a delineation of affected special aquatic sites, including wetlands (also see 33 CFR 330.1(e)); and

d. The discharge, including all attendant features, both temporary and permanent, is part of a single and complete project and is not placed for the purpose of a stream diversion. (Sections 10 and 404)

**19. Minor Dredging.** Dredging of no more than 25 cubic yards below the plane of the ordinary high water mark or the mean high water mark from navigable waters of the US (i.e., Section 10 waters) as part of a single and complete project. This NWP does not authorize the dredging or degradation through siltation of coral reefs, sites that support submerged aquatic vegetation (including sites where submerged aquatic vegetation is documented to exist, but may not be present in a given year), anadromous fish spawning areas, or wetlands, or the connection of canals or other artificial waterways to navigable waters of the US (see 33 CFR 322.5(g)). (Sections 10 and 404)

**33. Temporary Construction, Access and Dewatering.** Temporary structures, work and discharges, including cofferdams, necessary for construction activities or access fills or dewatering of construction sites; provided that the associated primary activity is authorized by the Corps of Engineers or the USCG, or for other construction activities not subject to the Corps or USCG regulations. Appropriate measures must be taken to maintain near normal downstream flows and to minimize flooding. Fill must be of materials, and placed in a manner, that will not be eroded by expected high flows. The use of dredged material may be allowed if it is determined by the District Engineer that it will not cause more than minimal adverse effects on aquatic resources. Temporary fill must be entirely removed to upland areas, or dredged material returned to its original location, following completion of the construction activity, and the affected areas must be restored to the pre-project conditions. Cofferdams cannot be used to dewater wetlands or other aquatic areas to change their use. Structures left in place after cofferdams are removed require a Section 10 permit if located in navigable waters of the U.S. (See 33 CFR part 322). The permittee must notify the District Engineer in accordance with the “Notification” General Condition. The notification must also include a restoration plan of reasonable measures to avoid and minimize adverse effects to aquatic resources. The District Engineer will add special conditions, where necessary, to ensure environmental adverse effects is minimal. Such conditions may include: limiting the temporary work to the minimum necessary; requiring seasonal restrictions; modifying the restoration plan; and requiring alternative construction methods (e.g. construction mats in wetlands where practicable.). (Sections 10 and 404)

The Public burden for this collection of information is estimated to average 10 hours per response, although the majority of applications should require 5 hours or less. This includes the time for reviewing instructions, searching existing data sources, gathering and maintaining the data needed, and completing and reviewing the collection of information. Send comments regarding this burden estimate or any other aspect of this collection of information, including suggestions for reducing this burden, to Department of Defense, Washington Headquarters Service Directorate of Information Operations and Reports, 1215 Jefferson Davis Highway, Suite 1204, Arlington, VA 22202-4302; and to the Office of Management and Budget, Paperwork Reduction Project (0710-0003), Washington, DC 20503. Respondents should be aware that notwithstanding any other provision of law, no person shall be subject to any penalty for failing to comply with a collection of information if it does not display a currently valid OMB control number. Please DO NOT RETURN your form to either of those addresses. Completed applications must be submitted to the District Engineer having jurisdiction over the location of the proposed activity.

**PRIVACY ACT STATEMENT**

Authorities: Rivers and Harbors Act, Section 10, 33 USC 403; Clean Water Act, Section 404, 33 USC 1344; Marine Protection, Research and Sanctuaries Act, Section 103, 33 USC 1413. Principal Purpose: Information provided on this form will be used in evaluating the application for a permit. Routine Uses: This information may be shared with the Department of Justice and other federal, state, and local government agencies. Submission of requested information is voluntary, however, if information is not provided the permit application cannot be evaluated nor can a permit be issued.

One set of original drawings or good reproducible copies which show the location and character of the proposed activity must be attached to this application (see sample drawings and instructions) and be submitted to the District Engineer having jurisdiction over the location of the proposed activity. An application that is not completed in full will be returned.

**(ITEMS 1 THRU 4 TO BE FILLED BY THE CORPS)**

1. APPLICATION NO.	2. FIELD OFFICE CODE	3. DATE RECEIVED	4. DATE APPLICATION COMPLETED
--------------------	----------------------	------------------	-------------------------------

**(ITEMS BELOW TO BE FILLED BY APPLICANT)**

5. APPLICANT'S NAME	8. AUTHORIZED AGENT'S NAME AND TITLE <i>(an agent is not required)</i>
6. APPLICANT'S ADDRESS	9. AGENT'S ADDRESS
7. APPLICANT'S PHONE NOS. W/AREA CODE	10. AGENT'S PHONE NOS. W/AREA CODE
a. Residence	a. Residence
b. Business	b. Business

**11. STATEMENT OF AUTHORIZATION**

I hereby authorize, \_\_\_\_\_ to act in my behalf as my agent in the processing of this application and to furnish, upon request, supplemental information in support of this permit application.

APPLICANT'S SIGNATURE

DATE

**NAME, LOCATION AND DESCRIPTION OF PROJECT OR ACTIVITY**

12. PROJECT NAME OR TITLE <i>(see instructions)</i>	
13. NAME OF WATERBODY, IF KNOWN <i>(if applicable)</i>	14. PROJECT STREET ADDRESS <i>(if applicable)</i>
15. LOCATION OF PROJECT	
_____ COUNTY	_____ STATE

16. OTHER LOCATION DESCRIPTIONS, IF KNOWN, *(see instructions)*

17. DIRECTIONS TO THE SITE



18. Nature of Activity *(Description of project, include all features)*

19. Project Purpose *(Describe the reason or purpose of the project, see instructions)*

**USE BLOCKS 20-22 IF DREDGED AND/OR FILL MATERIAL IS TO BE DISCHARGED**

20. Reason(s) for Discharge

21. Type(s) of Material Being Discharged and the Amount of Each Type in Cubic Yards

22. Surface Area in Acres of Wetlands or Other Waters Filled *(see instructions)*

23. Is Any Portion of the Work Already Complete? Yes  No  IF YES, DESCRIBE THE COMPLETED WORK

24. Addresses of Adjoining Property Owners, Lessees, Etc., Whose Property Adjoins the Waterbody (If more than can be entered here, please attach a supplemental list).

25. List of Other Certifications or Approvals/Denials Received from other Federal, State or Local Agencies for Work Described in This Application.

AGENCY	TYPE APPROVAL*	IDENTIFICATION NUMBER	DATE APPLIED	DATE APPROVED	DATE DENIED

\*Would include but is not restricted to zoning, building and flood plain permits

26. Application is hereby made for a permit or permits to authorize the work described in this application. I certify that the information in this application is complete and accurate. I further certify that I possess the authority to undertake the work described herein or am acting as the duly authorized agent of the applicant.

\_\_\_\_\_  
SIGNATURE OF APPLICANT

\_\_\_\_\_  
DATE

\_\_\_\_\_  
SIGNATURE OF AGENT

\_\_\_\_\_  
DATE

The application must be signed by the person who desires to undertake the proposed activity (applicant) or it may be signed by a duly authorized agent if the statement in block 11 has been filled out and signed.

18 U.S.C. Section 1001 provides that: Whoever, in any manner within the jurisdiction of any department or agency of the United States knowingly and willfully falsifies, conceals, or covers up any trick, scheme, or disguises a material fact or makes any false, fictitious or fraudulent statements or representations or makes or uses any false writing or document knowing same to contain any false, fictitious or fraudulent statements or entry, shall be fined not more than \$10,000 or imprisoned not more than five years or both.

**Instructions for Preparing a  
Department of the Army Permit Application**

**Blocks 1 through 4.** To be completed by Corps of Engineers.

**Block 5. Applicant's Name.** Enter the name of the responsible party or parties. If the responsible party is an agency, company, corporation or other organization, indicate the responsible officer and title. If more than one party is associated with the application, please attach a sheet with the necessary information marked **Block 5**.

**Block 6. Address of Applicant.** Please provide the full address of the party or parties responsible for the application. If more space is needed, attach an extra sheet of paper marked Block 6.

**Block 7. Applicant Telephone Number(s).** Please provide the number where you can usually be reached during normal business hours.

**Blocks 8 through 11.** To be completed if you choose to have an agent.

**Block 8. Authorized Agent's Name and Title.** Indicate name of individual or agency, designated by you, to represent you in this process. An agent can be an attorney, builder, contractor, engineer or any other person or organization. Note: An agent is not required.

**Blocks 9 and 10. Agent's Address and Telephone Number.** Please provide the complete mailing address of the agent, along with the telephone number where he/she can be reached during normal business hours.

**Block 11. Statement of Authorization.** To be completed by applicant if an agent is to be employed.

**Block 12. Proposed Project Name or Title.** Please provide name identifying the proposed project (i.e., Landmark Plaza, Burned Hills Subdivision or Edsall Commercial Center).

**Block 13. Name of Waterbody.** Please provide the name of any stream, lake, marsh or other waterway to be directly impacted by the activity. If it is a minor (no name) stream, identify the waterbody the minor stream enters.

**Block 14. Proposed Project Street Address.** If the proposed project is located at a site having a street address (not a box number), please enter here.

**Block 15. Location of Proposed Project.** Enter the county and state where the proposed project is located. If more space is required, please attach a sheet with the necessary information marked Block 15.

**Block 16. Other Location Descriptions.** If available, provide the Section, Township and Range of the site and/or the latitude and longitude. You may also provide description of the proposed project location, such as lot numbers, tract numbers or you may choose to locate the proposed project site from a known point (such as the right descending bank of Smith Creek, one mile down from the Highway 14 bridge). If a large river or stream, include the river mile of the proposed project site if known.

**Block 17. Directions to the Site.** Provide directions to the site from a known location or landmark. Include highway and street numbers as well as names. Also provide distances from known locations and any other information that would assist in locating the site.

**Block 18. Nature of Activity.** Describe the overall activity or project. Give appropriate dimensions of structures such as wingwalls, dikes (identify the materials to be used in construction, as well as the methods by which the work is to be done), or excavations (length, width, and height). Indicate whether discharge of dredged or fill material is involved. Also, identify any structure to be constructed on a fill, piles or float supported platforms.

The written descriptions and illustrations are an important part of the application. Please describe, in detail, what you wish to do. If more space is needed, attach an extra sheet of paper marked **Block 18**.

**Block 19. Proposed Project Purpose.** Describe the purpose and need for the proposed project. What will it be used for and why? Also include a brief description of any related activities to be developed as the result of the proposed project. Give the approximate dates you plan to both begin and complete all work.

**Block 20. Reason(s) for Discharge.** If the activity involves the discharge of dredged and/or fill material into a wetland or other waterbody, including the temporary placement of material, explain the specific purpose of the placement of the material (such as erosion control).

**Block 21. Type(s) of Material Being Discharged and the Amount of Each Type in Cubic Yards.** Describe the material to be discharged and amount of each material to be discharged within Corps jurisdiction. Please be sure this description will agree with your illustrations. Discharge material includes: rock, sand, clay, concrete, etc.

**Block 22. Surface Areas of Wetlands or Other Waters Filled.** Describe the area to be filled at each location. Specifically identify the surface areas, or part thereof, to be filled. Also include the means by which the discharge is to be done (backhoe, dragline, etc.). If dredged material is to be discharged on an upland site, identify the site and the steps to be taken (if necessary) to prevent runoff from the dredged material back into a waterbody. If more space is needed, attach an extra sheet of paper marked **Block 22**.

**Block 23. Is Any Portion of the Work Already Complete?** Provide any background on any part of the proposed project already completed. Describe the area already developed, structures completed, any dredged or fill material already discharged, the type of material, volume in cubic yards, acres filled, if a wetland or other waterbody (in acres or square feet). If the work was done under an existing Corps permit, identify the authorization if possible.

**Block 24. Names and Addresses of Adjoining Property Owners, Lessees, etc., Whose Property Adjoins the Project Site.** List complete names and full mailing addresses of the adjacent property owners (public and private) lessees, etc., whose property adjoins the waterbody or aquatic site where the work is being proposed so that they may be notified of the proposed activity (usually by public notice). If more space is needed, attach an extra sheet of paper marked Block 24.

**Information regarding adjacent landowners is usually available through the office of the tax assessor in the county of counties where the project is to be developed.**

**Block 25. Information about Approvals or Denials by Other Agencies.** You may need the approval of other Federal, state or local agencies for your project. Identify any applications you have submitted and the status, if any (approved or denied) of each application. You need not have obtained all other permits before applying for a Corps permit.

**Block 26. Signature of Applicant or Agent.** The application must be signed by the owner or other authorized party (agent) . This signature shall be an affirmation that the party applying for the permit possesses the requisite property rights to undertake the activity applied for (including compliance with special conditions, mitigation, etc.).

#### DRAWINGS AND ILLUSTRATIONS

##### **General Information.**

Three types of illustrations are needed to properly depict the work to be undertaken. These illustrations or drawings are identified as a **Vicinity Map**, a **Plan View** or a **Typical Cross-Section Map**. Identify each illustration with a figure or attachment number.

Please submit one original, or good quality copy, of all drawings on 8 1/2x11 inch plain white paper (tracing paper or film may be substituted). Use the fewest number of sheets necessary for your drawings or illustrations.

Each illustration should identify the project, the applicant, and the type of illustration (vicinity map, plan view or cross-section) . **While illustrations need not be professional (many small, private project illustrations are prepared by hand), they should be clear, accurate and contain all necessary information.**

## Kentucky Division of Water

### General Certification--Nationwide Permit # 3-Maintenance

---

Last Updated on 6/18/2004

This General Certification is issued March 17, 2002, in conformity with the requirements of Section 401 of the Clean Water Act of 1977, as amended (33USC 1314), as well as Kentucky Statute KRS 224.16-070.

The Commonwealth of Kentucky hereby certifies under Section 401 of the Clean Water Act (CWA) that it has reasonable assurances that applicable water quality standards under Kentucky Administrative Regulations Title 401, Chapter 5, established pursuant to Sections 301, 302, 304, 306 and 307 of the CWA, will not be violated for the activity covered under 33 CFR Part 330 Appendix A(B) (3), namely maintenance, provided that the following conditions are met:

1. Impacts to jurisdictional wetlands **greater than 1 acre** will require mitigation and an individual Water Quality Certification from the Kentucky Division of Water prior to beginning of work.
2. Impacts to streams **greater than 200 linear feet** of stream length will require an individual Water Quality Certification from the Division of Water prior to beginning work.
  - o For the purpose of this General Certification, streams are defined as a solid or dashed blue line on the most recent version of USGS 1:24,000 topographic map.
3. For those projects impacting **less than 200 feet of stream** or 1 acre of wetland the following condition must be observed:
  - o Effective erosion and sedimentation control measures must be employed at all times during the project to prevent degradation of waters of the Commonwealth.
4. This General Certification shall not apply to those waters of the Commonwealth identified as Outstanding Resource Waters, Exceptional Waters or Cold Water Aquatic Habitat Waters, as designated by the Division of Water. An individual Water Quality Certification will be required for projects in these waters.

Non-compliance with the conditions of this general certification or violation of Kentucky water quality standards may result in civil penalties.

This general certification will expire on March 19, 2007, or sooner if the COE makes significant changes to this nationwide permit.

## Kentucky Division of Water

### General Certification -- Nationwide Permit #13 -- Bank Stabilization

---

Last Updated on 6/18/2004

This General Certification is issued March 17, 2002, in conformity with the requirements of Section 401 of the Clean Water Act of 1977, as amended (33 USC 1314), as well as Kentucky Statute KRS 224.16-070.

The Commonwealth of Kentucky hereby certifies under Section 401 of the Clean Water Act (CWA) that it has reasonable assurances that applicable water quality standards under Kentucky Administrative Regulations Title 401, Chapter 5, established pursuant to Sections 301, 302, 304, 306 and 307 of the CWA will not be violated for the activity covered under 33 CFR 330 (13), namely bank stabilization, provided that the following conditions are met:

1. Impacts to streams **greater than 200 linear feet** of stream length will require an individual Water Quality Certification from the Division of Water prior to beginning work, except as noted in condition 3 of this certification. For the purpose of this General Certification, streams are defined as a solid or dashed blue line on the most recent version of USGS 1:24,000 topographic map.
2. For those projects impacting **less than 200 feet** of stream or 1 acre of wetland the following condition must be observed:
  - o Effective erosion and sedimentation control measures must be employed at all times during the project to prevent degradation of waters of the Commonwealth.
3. Stream impacts covered under this nationwide permit and undertaken by those persons defined as an agricultural operation under the Agricultural Water Quality Act must be completed in compliance with the Kentucky Agricultural Water Quality Plan.
4. This General Certification shall not apply to those waters of the Commonwealth identified as Outstanding State Resource Waters, Exceptional Waters or Cold Water Aquatic Habitat Waters, as designated by the Division of Water. An individual Water Quality Certification will be required for projects in these waters.

Non-compliance with the conditions of this general certification or violation of Kentucky state water quality standards may result in civil penalties.

This general certification will expire on March 19, 2007, or sooner if the COE makes significant changes to this nationwide permit.

**COMMONWEALTH OF KENTUCKY  
NATURAL RESOURCES & ENVIRONMENTAL PROTECTION CABINET  
DEPARTMENT FOR ENVIRONMENTAL PROTECTION  
DIVISION OF WATER**

**APPLICATION FOR PERMIT TO CONSTRUCT ACROSS OR ALONG A STREAM  
AND / OR WATER QUALITY CERTIFICATION**

Chapter 151 of the Kentucky Revised Statutes requires approval from the Division of Water prior to any construction or other activity in or along a stream that could in any way obstruct flood flows or adversely impact water quality. *If the project involves work in a stream, such as bank stabilization, dredging or relocation, you will also need to obtain a 401 Water Quality Certification (WQC) from the Division of Water.* This completed form will be forwarded to the Water Quality Branch for WQC processing. The project may not start until all necessary approvals are received from the KDOW. For questions concerning the WQC process, contact the Water Quality Certification section at 502/564-3410.

If the project will disturb more than 1 acre of soil, you will also need to complete the attached Notice of Intent for Storm Water Discharges, and return both forms to the Floodplain management Section of the KDOW. This general permit will require you to create an implement an erosion control plan for the project.

1. **OWNER:** \_\_\_\_\_  
Give name of person(s), company, governmental unit, or other owner of proposed project.

**MAILING ADDRESS:** \_\_\_\_\_

**TELEPHONE #:** \_\_\_\_\_ **EMAIL:** \_\_\_\_\_

2. **AGENT:** \_\_\_\_\_  
Give name of person(s) submitting application, if other than owner.

**ADDRESS:** \_\_\_\_\_

**TELEPHONE #:** \_\_\_\_\_ **EMAIL:** \_\_\_\_\_

3. **ENGINEER:** \_\_\_\_\_ **P.E. NUMBER:** \_\_\_\_\_  
Contact Division of Water if waiver can be granted.

**TELEPHONE #:** \_\_\_\_\_ **EMAIL:** \_\_\_\_\_

4. **DESCRIPTION OF CONSTRUCTION:** \_\_\_\_\_  
Describe the type and purpose of construction and describe stream impact

\_\_\_\_\_  
\_\_\_\_\_  
\_\_\_\_\_  
\_\_\_\_\_

5. **COUNTY:** \_\_\_\_\_ **NEAREST COMMUNITY:** \_\_\_\_\_

6. **USGS QUAD NAME** \_\_\_\_\_ **LATITUDE/LONGITUDE:** \_\_\_\_\_

7. **STREAM NAME:** \_\_\_\_\_ **WATERSHED SIZE (in acres):** \_\_\_\_\_

8. **LINEAR FEET OF STREAM IMPACTED:** \_\_\_\_\_

9. **DIRECTIONS TO SITE:** \_\_\_\_\_

\_\_\_\_\_  
\_\_\_\_\_  
\_\_\_\_\_  
\_\_\_\_\_

10. **IS ANY PORTION OF THE REQUESTED PROJECT NOW COMPLETE?** Yes No If yes, identify the completed portion on the drawings you submit and indicate the date activity was completed. DATE: \_\_\_\_\_
11. **ESTIMATED BEGIN CONSTRUCTION DATE:** \_\_\_\_\_
12. **ESTIMATED END CONSTRUCTION DATE:** \_\_\_\_\_
13. **HAS A PERMIT BEEN RECEIVED FROM THE US ARMY, CORPS of ENGINEERS?** Yes No If yes, attach a copy of that permit.
14. **THE APPLICANT *MUST* ADDRESS PUBLIC NOTICE:**

**(a) PUBLIC NOTICE HAS BEEN GIVEN FOR THIS PROPOSAL BY THE FOLLOWING MEANS:**

- \_\_\_\_ Public notice in newspaper having greatest circulation in area (provide newspaper clipping or affidavit)
- \_\_\_\_ Adjacent property owner(s) affidavits (Contact Division of Water for requirements.)

**(b) \_\_\_\_\_ I REQUEST WAIVER OF PUBLIC NOTICE BECAUSE:**

\_\_\_\_\_  
 Contact Division of Water for requirements.

15. **I HAVE CONTACTED THE FOLLOWING CITY OR COUNTY OFFICIALS CONCERNING THIS PROJECT:**

\_\_\_\_\_  
 Give name and title of person(s) contacted and provide copy of any approval city or county may have issued.

16. **LIST OF ATTACHMENTS:** \_\_\_\_\_

List plans, profiles, or other drawings and data submitted. Attach a copy of a 7.5 minute USGS topographic map clearly showing the project location.

17. **I, \_\_\_\_\_ (owner) CERTIFY THAT THE OWNER OWNS OR HAS EASEMENT RIGHTS ON ALL PROPERTY ON WHICH THIS PROJECT WILL BE LOCATED OR ON WHICH RELATED CONSTRUCTION WILL OCCUR (for dams, this includes the area that would be impounded during the design flood).**

18. **REMARKS:** \_\_\_\_\_

I hereby request approval for construction across or along a stream as described in this application and any accompanying documents. To the best of my knowledge, all the information provided is true and correct.

**SIGNATURE:** \_\_\_\_\_  
 Owner or Agent sign here. (If signed by Agent, a Power of Attorney should be attached.)

**DATE:** \_\_\_\_\_

**SIGNATURE OF LOCAL FLOODPLAIN COORDINATOR:**

\_\_\_\_\_  
 Permit application will be returned to applicant if not properly endorsed by the local floodplain coordinator.

**DATE:** \_\_\_\_\_

**SUBMIT APPLICATION AND ATTACHMENTS TO:**

Floodplain Management Section  
 Division of Water  
 14 Reilly Road  
 Frankfort, KY 40601

## **Appendix 16. Special Use Waters**





## APPENDIX 16: SPECIAL USE WATERS DEFINITIONS AND NOTES

**Cold water aquatic habitat (CAH)** means surface waters and associated substrate that will support indigenous aquatic life or self-sustaining or reproducing trout populations on a year-round basis. (401 KAR 5:031, Section 4).

**Domestic water supply (DWS)** means surface waters that with conventional treatment are suitable for human consumption through a public water system as defined in 401 KAR 8:010, culinary purposes, or for use in any food or beverage processing industry; and meet state and federal regulations under the Safe Drinking Water Act, as amended, 42 U.S.C. 300f - 300j. (401 KAR 5:031, Section 5). **The area of concern extends 300 feet upstream to 2000 feet downstream of the intake structure. This classification should serve as a trigger to check for intakes within the area of concern.**

**Exceptional waters (EXC)** means waterbodies whose quality exceeds that necessary to support propagation of fish, shellfish, and wildlife and recreation in and on the water. This classification includes "Reference Reach" waters. (401 KAR 5:030, Section 3).

**National Wild and Scenic River (NWSR)** means river(s) that possesses outstandingly remarkable scenic, recreational, geologic, fish and wildlife, historic, cultural, or other similar values, shall be preserved in free-flowing condition, and that they and their immediate environments shall be protected for the benefit and enjoyment of present and future generations. (P.L. 90-542, as amended)

**Outstanding National Resource Waters (ONRW)** are waters that meet the requirements for an outstanding state resource water classification and are of national ecological or recreational significance. They are listed in 401 KAR 5:030, Section 3.

**Outstanding state resource waters (OSRW)** means surface waters designated by the cabinet pursuant to 401 KAR 5:031, Section 7, and includes certain unique waters of the Commonwealth.

**Wild River (WR)** means a stream segment and adjacent shoreland within boundaries set forth in 401 KAR 4:100 which are designated in accordance with KRS 146.241. (401 KAR 4:100)

**Threatened and Endangered Species (T&E)** critical habitat for Federally listed threatened and endangered species. Endangered means any species in danger of extinction throughout all or a significant portion of its range. Threatened means any species likely to become an endangered species within the foreseeable future in all or a significant portion of its range. Locations of critical habitat for federally-listed Threatened and Endangered Species and State Natural Heritage Sites is kept confidential to facilitate protection of these special areas. Work with the Environmental Coordinator to determine if these issues are important to the proposed work area.

**State Natural Heritage Site (SNHS)** KSNPC's staff botanists, zoologists, ecologists, land managers, and data managers work with others to protect our natural heritage and educate Kentuckians about its importance. Information on rare and sensitive plants, animals, ecological communities and other natural features of Kentucky is maintained as part of a computer data management system known as the Kentucky Natural Heritage Program (KYNHP). (400 KAR 2)

**Note:** Critical Resource Waters List may be amended every 3 years as part of the triennial review for Surface Water Standards. Update this appendix as needed in **2007**. Contact the KDOW Water Quality Branch for additional information.

**APPENDIX 16: SPECIAL USE WATERS**

County	Watershed	Water Body	Description	River Mile	CAH	EXC	NWSR	ONRW	OSRW	WR
Adair	Green	Ellis Fork	Mouth to Headwaters	0.0-3.2		EXC				
Adair	Green	Green River Unidentified Tributary	Landuse Change to Headwaters	0.8-3.2		EXC				
Adair	Green	Russell Creek	Mouth to Columbia WWTP	0.0-40.0		EXC				
Adair	Green	Russell Creek	Reynolds Creek to Headwaters	55.9-68.2		EXC				
Adair	Green	White Oak Creek Unidentified Tributary	Hovious Rd Crossing to SR 76	0.4-3.0		EXC				
Allen	Green	Trammel Fork	Mouth to Tennessee Stateline	0.0-30.15		EXC				
Allen	Green	Trammel Fork	River Mile 30.15 (Kentucky/ Tennessee State Line) to Hwy 31E (River Mile 23.6)	23.6-30.15	CAH					
Anderson	Salt	Sulphur Creek	Mouth to Chesse Lick and Brush Creek	0.0-9.7		EXC				
Ballard	Ohio	Ohio River	River Mile 948.2 to River Mile 949.5	948.2-949.5					OSRW	
Ballard	Ohio	Ohio River	River Mile 966.3 to River Mile 969.5						OSRW	
Ballard	Ohio	Swan	Entire Lake			EXC			OSRW	
Barren	Green	Caney Fork	Mouth to Headwaters	0.0-6.6		EXC				
Barren	Green	Peter Creek	Caney Fork to Dry Fork	11.6-18.5		EXC				
Bath, Rowan	Licking	Licking River	River Mile 165.0 to River Mile 154.5			EXC			OSRW	
Bath, Rowan	Licking	Licking River	River Mile 176.8 (Cave Run Lake Dam) to River Mile 169.6 (U.S. Highway 60 Bridge)		CAH					
Bell	Upper Cumberland	Bennetts Fork of Yellow Creek	Basin (Kentucky/Tennessee State Line) above River Mile 5.0						OSRW	
Bell	Upper Cumberland	Bens Fork of Little Clear Creek	Basin						OSRW	
Bell	Upper Cumberland	Blacksnake Branch	Basin						OSRW	
Bell	Upper Cumberland	Brownies Creek	Blacksnake Branch to Headwaters	9.0-16.0		EXC				
Bell	Upper Cumberland	Caney Creek	Basin						OSRW	
Bell	Upper Cumberland	Cannon Creek	Basin above Cannon Creek Lake						OSRW	
Bell	Upper Cumberland	Cannon Creek Reservoir	Entire Reservoir		CAH					
Bell	Upper Cumberland	Colliers Creek	Basin						OSRW	
Bell	Upper Cumberland	Davis Branch	Basin						OSRW	

**APPENDIX 16: SPECIAL USE WATERS**

County	Watershed	Water Body	Description	River Mile	CAH	EXC	NWSR	ONRW	OSRW	WR
Bell	Upper Cumberland	Four Mile Creek	Basin above River Mile 2.5						OSRW	
Bell	Upper Cumberland	Four Mile Run	Basin above River Mile 1.0						OSRW	
Bell	Upper Cumberland	Laurel Fork of Clear Fork	Basin above River Mile 16.0						OSRW	
Bell	Upper Cumberland	Lick Fork	Basin						OSRW	
Bell	Upper Cumberland	Long Branch	Basin						OSRW	
Bell	Upper Cumberland	Mill Creek of Straight Creek	Basin						OSRW	
Bell	Upper Cumberland	Shillalah Creek	Mouth to Headwaters	0.0-5.5		EXC				
Bell	Upper Cumberland	Shillalah Creek	Source to Cumberland Gap National Historical Park Boundary		CAH					
Bell	Upper Cumberland	Sims Fork	Basin						OSRW	
Bell	Upper Cumberland	Stevenson Branch	Basin						OSRW	
Bell	Upper Cumberland	Stony Fork of Bennetts Fork	Basin above River Mile 2.2						OSRW	
Boone	Ohio	Double Lick Creek	Mouth to Landuse Change	0.0-1.4		EXC				
Boone	Ohio	Garrison Creek	Mouth to Headwaters	0.0-4.1		EXC				
Boone	Ohio	Second Creek	Private Road Crossing to Headwaters	0.5-2.9		EXC				
Breathitt	Kentucky	Clemons Fork	Mouth to Headwaters	0.0-4.7		EXC				
Breathitt	Kentucky	Coles Fork	Mouth to Headwaters	0.0-5.5		EXC				
Breathitt	Kentucky	Falling Rock Branch	Mouth to Headwaters	0.0-0.6		EXC				
Breathitt	Kentucky	John Carpenter Fork	Mouth to Headwaters	0.0-1.5		EXC				
Breathitt	Kentucky	Little Millseat Branch	Mouth to Headwaters	0.0-1.2		EXC				
Breathitt	Kentucky	Millseat Branch	Mouth to Headwaters	0.0-1.9		EXC				
Breathitt	Kentucky	Roaring Fork	Mouth to Headwaters	0.0-0.85		EXC				
Breathitt	Kentucky	Shelly Rock Fork	Mouth to Headwaters	0.0-0.6		EXC				
Breckinridge	Green	Fiddlers Creek	Mouth to Headwaters	0.0-5.8		EXC				
Breckinridge	Green	North Fork Rough River	Buffalo Creek to Reservoir Dam	23.44-28.1		EXC				
Breckinridge	Ohio	Sinking Creek	Source to Hwy 259 (River Mile 4.0)		CAH					
Breckinridge	Ohio	Yellowbank Creek	Ohio River Backwaters to Headwaters	1.4-11.4		EXC				

**APPENDIX 16: SPECIAL USE WATERS**

County	Watershed	Water Body	Description	River Mile	CAH	EXC	NWSR	ONRW	OSRW	WR
Breckinridge, Ohio	Green	Pond Run	Landuse Change to Headwaters	1.4-6.8		EXC				
Bullitt	Salt	Cedar Creek	Mouth to Greens Branch	0.0-5.1		EXC				
Bullitt	Salt	Harts Run	Mouth to Headwaters	0.0-2.3		EXC				
Bullitt	Salt	Overalls Creek	Mouth to Headwaters	0.0-1.3		EXC				
Bullitt	Salt	Wilson Creek	Mouth to Headwaters	0.0-17.0		EXC				
Butler	Green	Green River	River Mile 168.0 to River Mile 148.0						OSRW	
Butler, Warren	Green	Barren River	River Mile 15.0 to Green River						OSRW	
Caldwell	Tradewater	East Fork Flynn Fork	Landuse Change to Headwaters	2.5-4.6		EXC				
Caldwell	Tradewater	Piney Creek	Lake Beshear Backwaters to Headwaters	4.5-10.2		EXC				
Caldwell	Tradewater	Piney Creek Unidentified Tributary	Mouth to Headwaters	0.0-2.9		EXC				
Calloway	Tennessee	Blood River	McCullough Fork to Tennessee Stateline	12.2-15.65		EXC				
Calloway	Tennessee	Grindstone Creek	Mouth to Headwaters	0.0-2.3		EXC				
Calloway	Tennessee	Panther Creek	Mouth to Headwaters	0.0-5.1		EXC				
Calloway	Tennessee	Sugar Creek	Kentucky Lake Backwaters to Buzzard Roost Road	2.1-3.3		EXC				
Calloway	Tennessee	Wildcat Creek	Ralph Wright Road Crossing to Headwaters	3.5-6.7		EXC				
Carlisle	Mississippi	Mississippi River	River Mile 935.0 to River Mile 930.0						OSRW	
Carlisle	Mississippi	Mississippi River	River Mile 947.0 to River Mile 945.0						OSRW	
Carroll	Kentucky	Indian Creek	Backwater Kentucky River to Headwaters	0.55-4.7		EXC				
Carter	Little Sandy	Arabs Fork	Clay Fork to Headwaters	0.0-4.7		EXC				
Carter	Little Sandy	Big Sinking Creek	SR 986 to Clay Fork and Arab Fork	10.7-15.2		EXC				
Casey	Green	Goose Creek	Mouth to Little Goose Creek	0.0-8.1		EXC				
Christian	Green	Forbes Creek	Mouth to Unidentified Tributary	0.0-3.9		EXC				
Christian	Green	McFarland Creek	Grays Branch to Unidentified Tributary	1.4-4.8		EXC				
Christian	Green	West Fork Pond River	Unidentified Tributary to East Branch Pond River	12.7-22.5		EXC				
Christian	Lower Cumberland	West Fork of Red River	River Mile 32.2 to Kentucky/Tennessee State Line (River Mile 14.5)		CAH					
Christian	Lower Cumberland	West Fork of Red River	Tennessee Stateline to Montgomery Creek	16.1-26.5		EXC				
Christian	Tradewater	Sandlick Creek	Camp Creek to Headwaters	4.9-9.0		EXC				

**APPENDIX 16: SPECIAL USE WATERS**

County	Watershed	Water Body	Description	River Mile	CAH	EXC	NWSR	ONRW	OSRW	WR
Christian	Tradewater	Sandlick Creek Unidentified Tributary	Mouth to Headwaters	0.0-1.4		EXC				
Christian	Tradewater	Tradewater River	Dripping Springs Branch to Buntin Lake Dam	123.2-131.1		EXC				
Clark, Powell	Kentucky	Lulbegrud Creek	Mouth to Falls Branch	0.0-7.3		EXC				
Clay	Kentucky	Bert Combs	Entire Reservoir		CAH					
Clay	Kentucky	Big Double Creek	Mouth to Headwaters	0.0-6.5		EXC				
Clay	Kentucky	Goose Creek	Mouth to Laurel Creek	0.0-9.3		EXC				
Clay	Kentucky	Left Fork Big Double Creek	Mouth to Headwaters	0.0-1.5		EXC				
Clay	Kentucky	Red Bird River	Mouth to Big Creek	0.0-15.0		EXC				
Clinton	Upper Cumberland	Howards Creek	Dale Hollow lake Backwaters to Headwaters	0.8-3.4		EXC				
Clinton	Upper Cumberland	Sulphur Creek	Dale Hollow Backwaters to Headwaters	2.0-5.1		EXC				
Crittenden	Ohio	Crooked Creek	Rush Creek to City Lake Dam	17.5-25.6		EXC				
Cumberland	Upper Cumberland	Mud Camp Creek	Mouth to Collins Branch	0.0-1.3		EXC				
Edmonson	Green	Beaverdam Creek	Source to Green River	0.0-14.1	CAH	EXC				
Edmonson	Green	Echo River	Basin Outside Mammoth Cave National Park Boundary		CAH				OSRW	
Edmonson	Green	Ganter Spring	Basin Outside Mammoth Cave National Park Boundary		CAH				OSRW	
Edmonson	Green	Green River	Downstream Mammoth Cave National Park Boundary to Lynn Camp Creek	181.7-207.8		EXC			OSRW	
Edmonson	Green	Nolin River	River Mile 7.6 (Nolin Lake Dam) to Green River		CAH					
Edmonson	Green	Pike Spring	Basin Outside Mammoth Cave National Park Boundary		CAH				OSRW	
Edmonson	Green	Running Spring	Basin Outside Mammoth Cave National Park Boundary		CAH				OSRW	
Edmonson	Green	Sulphur Branch	Mouth to Headwaters	0.0-2.0		EXC				
Edmonson, Barren	Green	Double Sink Spring	Basin Outside Mammoth Cave National Park Boundary		CAH				OSRW	
Edmonson, Barren	Green	Turnhole Spring	Basin Outside Mammoth Cave National Park Boundary		CAH				OSRW	

**APPENDIX 16: SPECIAL USE WATERS**

County	Watershed	Water Body	Description	River Mile	CAH	EXC	NWSR	ONRW	OSRW	WR
Edmonson, Hart, Barren	Green	Underground River System	Within Mammoth Cave National Park Boundary		CAH			ONRW	OSRW	
Edmonson, Hart	Green	Green River	River Mile 207.8 to River Mile 181.7							WR
Edmonson, Hart	Green	Green River	River Mile 207.8 to River Mile 181.7							WR
Elliott	Little Sandy	Big Caney Creek	Source to Grayson Lake	0.0-14.9	CAH	EXC				
Elliott	Little Sandy	Laurel Creek	Carter School Rd Bridge to Headwaters	7.6-14.4		EXC				
Elliott	Little Sandy	Laurel Creek	Source to Little Sandy River		CAH					
Elliott	Little Sandy	Meadow Branch	Mouth to Headwaters	0.0-1.4		EXC				
Elliott	Little Sandy	Middle Fork Little Sandy River	Mouth to Sheepskin Branch	0.0-3.6		EXC				
Elliott	Little Sandy	Nichols Fork	Green Branch to Headwaters	0.0-1.9		EXC				
Estill	Kentucky	Evans Fork	Mouth to Headwaters	0.0-2.9		EXC				
Estill	Kentucky	Station Camp Creek	Landuse Change to South Fork Station Camp Creek	19.0-22.3		EXC				
Franklin	Kentucky	Grindstone Creek	Mouth to Headwaters	0.0-2.2		EXC				
Gallatin	Ohio	Big Sugar Creek Unidentified Tributary	I-71 to Headwaters	1.0-3.6		EXC				
Garrard, Mercer	Kentucky	Dix River	Herrington Lake Dam to Kentucky River		CAH					
Grant	Kentucky	Musselman Creek	Mouth to Headwaters	0.0-8.4		EXC				
Graves	Mississippi	Cane Creek of Bayou de Chien	Basin						OSRW	
Graves	Mississippi	Jackson Creek	Basin						OSRW	
Graves	Mississippi	Jackson Creek	Mouth to Headwaters	0.0-2.6		EXC				
Graves	Mississippi	Sand Creek	Basin						OSRW	
Graves	Mississippi	South Fork of Bayou de Chien	Basin						OSRW	
Graves	Mississippi	Terrapin Creek	Tennessee Stateline to Headwaters	2.8-7		EXC				
Graves	Tennessee	Panther Creek	Channelization to Impoundment	1.1-6.0		EXC				
Graves	Tennessee	Panther Creek Unidentified Tributary	Mouth to Headwaters	0.0-2.1		EXC				
Graves	Tennessee	Sugar Creek	Mouth to Unnamed Reservoir	0.0-4.0		EXC				
Graves	Tennessee	Trace Creek	Mouth to Neeley Branch	0.0-3.0		EXC				
Graves	Tennessee	West Fork Clarks River	Soldier Creek to Duncan Creek	19.7-22.7		EXC				
Grayson	Green	Clifty Creek	Barton Run to Western Kentucky Parkway	7.3-17.2		EXC				

**APPENDIX 16: SPECIAL USE WATERS**

County	Watershed	Water Body	Description	River Mile	CAH	EXC	NWSR	ONRW	OSRW	WR
Grayson	Green	Little Short Creek	Mouth to Headwaters	0.0-3.0		EXC				
Greenup	Little Sandy	Greenbo	Entire Reservoir		CAH					
Hardin	Green	Linders Creek	Mouth to Sutzer Creek	0.0-7.7		EXC				
Hardin	Green	Meeting Creek	Little Meeting Creek to Petty Branch	5.2-13.8		EXC				
Hardin	Green	Rough River	Linders Creek to Vertrees Creek	136.9-147.8		EXC				
Harlan	Upper Cumberland	Breeden's Creek	Basin						OSRW	
Harlan	Upper Cumberland	Brownies Creek	Basin to River Mile 10.0						OSRW	
Harlan	Upper Cumberland	Fugitt Creek	Basin		CAH					
Harlan	Upper Cumberland	Fugitt Creek	Landuse Change to Headwaters	0.5-4.9		EXC				
Harlan	Upper Cumberland	Looney Creek	Basin above River Mile 5.3		CAH					
Harlan	Upper Cumberland	Martins Fork of Cumberland River	Basin above River Mile 31.3		CAH					
Harlan	Upper Cumberland	Martins Fork of Cumberland River	Wild River Boundaries River Mile 31.3 to River Mile 27.4	27.4-31.3	CAH	EXC			OSRW	WR
Harlan	Upper Cumberland	Watts Creek	Basin above Camp Blanton Lake						OSRW	
Harlan	Upper Cumberland	Watts Creek	Lake to Headwaters	2.2-4.3		EXC				
Hart	Green	Cane Run	Nolin River Backwaters to Headwaters	1-6.5		EXC				
Hart	Green	Green River	River Mile 305.6 (Green River Lake Dam) to River Mile 207.8						OSRW	
Hart	Green	Lynn Camp Creek	Mouth to Lindy Creek	0.0-8.3		EXC				
Hart	Green	Lynn Camp Creek	Source to Green River		CAH					
Hart	Green	McCoy Spring	Basin Outside Mammoth Cave National Park Boundary		CAH				OSRW	
Hart	Green	Mile 205.7 Spring	Basin Outside Mammoth Cave National Park Boundary		CAH				OSRW	
Hart	Green	Roundstone Creek	Source to Hwy 1140 (River Mile 3.5)		CAH					
Hart, Barren	Green	Suds Spring	Basin Outside Mammoth Cave National Park Boundary		CAH				OSRW	
Henry	Kentucky	Drennon Creek	Flat Bottom Road Crossing to Town Branch	10.5-11.9		EXC				
Henry	Kentucky	Emily Run	Mouth to Unidentified Tributary	0.0-3.9		EXC				



**APPENDIX 16: SPECIAL USE WATERS**

County	Watershed	Water Body	Description	River Mile	CAH	EXC	NWSR	ONRW	OSRW	WR
Henry	Kentucky	Little Sixmile Creek	Mouth to Headwaters	0.0-5.2		EXC				
Henry	Kentucky	Sand Ripple Creek	Mouth to Headwaters	0.0-3.9		EXC				
Henry	Kentucky	Sixmile Creek	Little Sixmile to Dam	6.9-14.7		EXC				
Hickman	Mississippi	Bayou de Chien	Source to River Mile 13.0						OSRW	
Hickman	Mississippi	Murphy's Pond	Entire Pond and Preserve Area			EXC				
Hickman	Mississippi	Murphy's Pond	Entire Pond and Preserve Area						OSRW	
Hickman	Mississippi	Obion Creek	Hurricane Creek to Little Creek	25.2-35.5		EXC				
Jackson	Kentucky	Cavanaugh Creek	South Fork of Station Camp Creek to Foxtown Rd	0.0-5.3		EXC				
Jackson	Kentucky	Hopper Cave Branch	Mouth to Headwaters	0.0-1.6		EXC				
Jackson	Kentucky	South Fork of Station Camp Creek	Mouth to Rock Lick Creek	0.0-9.6		EXC				
Jackson	Kentucky	Steer Fork	Mouth to Headwaters	0.0-2.9		EXC				
Jackson	Kentucky	War Fork	Mouth to Headwaters	0.0-13.7		EXC				
Jackson	Kentucky	War Fork of Station Camp Creek	River Mile 8.5 to River Mile 2.0		CAH					
Jackson	Upper Cumberland	Beulah (Tyner)	Entire Reservoir		CAH					
Jackson	Upper Cumberland	Clover Bottom Creek	River Mile 1.4 to Horselick Creek		CAH					
Jackson	Upper Cumberland	Horse Lick Creek	Mouth to Clover Bottom	0.0-12.3		EXC				
Jackson	Upper Cumberland	Laurel Fork	Mouth to Headwaters	0.0-12.2		EXC				
Jackson	Upper Cumberland	Laurel Fork	Source to Middle Fork of Rockcastle River						OSRW	
Jackson	Upper Cumberland	Middle Fork of Rockcastle River	River Mile 61.1 to River Mile 53.3						OSRW	
Jackson	Upper Cumberland	Middle Fork Rockcastle River	Mouth to Horse Lick Creek	0.0-7.8		EXC				
Jackson, Rockcastle	Upper Cumberland	Horse Lick Creek	River Mile 12.3 to Middle Fork of Rockcastle River						OSRW	
Johnson	Big Sandy	Paint Creek of Levisa Fork	River Mile 8.3 (Paintsville Lake Dam) to Levisa Fork		CAH					
Johnson	Big Sandy	Paintsville	Entire reservoir		CAH					
Kenton, Campbell	Licking	Licking River	River Mile 115.0 to River Mile 18.9						OSRW	

**APPENDIX 16: SPECIAL USE WATERS**

County	Watershed	Water Body	Description	River Mile	CAH	EXC	NWSR	ONRW	OSRW	WR
Knox	Upper Cumberland	Acorn Fork	Basin above River Mile 1.0						OSRW	
Knox	Upper Cumberland	Brices Creek	Basin						OSRW	
Knox	Upper Cumberland	Coles Branch	Basin						OSRW	
Knox	Upper Cumberland	Hale Fork	Basin						OSRW	
Knox	Upper Cumberland	Hinkle Branch	Basin						OSRW	
Knox	Upper Cumberland	Honeycutt Branch	Basin						OSRW	
Knox	Upper Cumberland	Hunting Shirt Branch	Basin						OSRW	
Knox	Upper Cumberland	Little Poplar Creek	Basin above and including East Ridge Branch						OSRW	
Knox	Upper Cumberland	Mill Branch	Basin						OSRW	
Knox	Upper Cumberland	Moores Creek	Basin						OSRW	
Knox	Upper Cumberland	Mud Lick	Basin						OSRW	
Knox	Upper Cumberland	Richland Creek	Basin above River Mile 15.7						OSRW	
Knox	Upper Cumberland	Roaring Fork	Basin						OSRW	
Knox	Upper Cumberland	Trace Branch	Basin						OSRW	
Knox	Upper Cumberland	Turkey Creek	Basin						OSRW	
Larue	Salt	Otter Creek	Landuse Change to East Fork and Middle Fork Otter Creek	1.7-2.7		EXC				
Larue	Salt	West Fork Otter Creek	Mouth to Headwaters	0.0-4.7		EXC				
Larue, Nelson	SALT	Rolling Fork of Salt River	River Mile 62.5 to River Mile 53.6						OSRW	
Laurel	Upper Cumberland	Cane Creek	Mouth to Headwaters	0.0-12.0		EXC				

**APPENDIX 16: SPECIAL USE WATERS**

County	Watershed	Water Body	Description	River Mile	CAH	EXC	NWSR	ONRW	OSRW	WR
Laurel	Upper Cumberland	Hawk Creek	Basin		CAH					
Laurel	Upper Cumberland	Laurel River	Laurel River Lake Dam (River Mile 2.1) to River Mile 0.9		CAH					
Laurel	Upper Cumberland	Ned Branch	Basin						OSRW	
Laurel	Upper Cumberland	Sinking Creek	Mouth to White Oak Creek	0.0-9.8		EXC				
Laurel	Upper Cumberland	Sinking Creek	Source to Rockcastle River						OSRW	
Laurel	Upper Cumberland	South Fork Rockcastle River	Mouth to White Oak Creek	0.0-5.6		EXC				
Laurel	Upper Cumberland	White Oak Creek	Basin above River Mile 1.2 (includes Little White Oak Creek)		CAH					
Laurel	Upper Cumberland	Wood Creek	Entire Reservoir		CAH					
Laurel	Upper Cumberland	Wood Creek	River Mile 4.0 (Wood Creek Lake Dam) to Hazel Patch Creek		CAH					
Laurel, Pulaski	Upper Cumberland	Rockcastle River	River Mile 53.3 to River Mile 8.5						OSRW	
Laurel, Pulaski, Rockcastle	Upper Cumberland	Rockcastle River	Wild River Boundaries	8.5-24.4		EXC				WR
Laurel, Whitley	Upper Cumberland	Laurel River	Entire Reservoir		CAH					
Lee	Kentucky	Middle Fork of Kentucky River	Mouth to Upper Twin Creek	0.0-12.5		EXC				
Lee	Kentucky	Sturgeon Creek	Duck Fork to Little Sturgeon Creek	1.3-13.7		EXC				
Leslie	Kentucky	Bill Branch	Mouth to Right Fork and Left Fork Creek	0.0-2.2		EXC				
Leslie	Kentucky	Cawood Branch	Mouth to Headwaters	0.0-2.1		EXC				
Leslie	Kentucky	Elisha Creek	Elisha Creek Rd Crossing to Right Fork and Middle Fork Elisha Creek	0.95-1.7		EXC				
Leslie	Kentucky	Hell For Certain	Mouth to Big Fork	0.0-2.1		EXC				
Leslie	Kentucky	Honey Branch	Mouth to Headwaters	0.0-1.4		EXC				
Leslie	Kentucky	Middle Fork of Kentucky River	Hyden, Kentucky to Greasy Creek	76.1-84.0		EXC				
Leslie	Kentucky	Spruce Branch	Mouth to Headwaters	0.0-1.1		EXC				

**APPENDIX 16: SPECIAL USE WATERS**

County	Watershed	Water Body	Description	River Mile	CAH	EXC	NWSR	ONRW	OSRW	WR
Leslie	Kentucky	Sugar Creek	Landuse Change to Headwaters	0.8-3.8		EXC				
Letcher	Kentucky	Fishpond	Entire Reservoir		CAH					
Letcher	Kentucky	Line Fork	Defeated Creek to Headwaters	11.6-27.5		EXC				
Letcher	Kentucky	Line Fork Unidentified Tributary (LCW)	Mouth to Headwaters	0.0-0.55		EXC				
Letcher	Upper Cumberland	Bad Branch	Basin		CAH	EXC			OSRW	WR
Letcher	Upper Cumberland	Meadow Fork	Basin						OSRW	
Letcher	Upper Cumberland	Poor Fork Cumberland River	Franks Creek to Headwaters	46.1-51.7		EXC				
Letcher	Upper Cumberland	Poor Fork of Cumberland River	Basin above River Mile 742.5		CAH				OSRW	
Letcher	Upper Cumberland	Presley House Branch	Mouth to Headwaters	0.0-1.5		EXC				
Letcher	Upper Cumberland	Smith Creek	Basin						OSRW	
Lewis	Ohio	Kinniconick Creek	McDowell Creek to Headwaters	5.1-50.4		EXC				
Livingston	Lower Cumberland	Sugar Creek	Lick Creek to Unidentified Tributary	2.1-6.7		EXC				
Livingston	Ohio	Ohio River	River Mile 922.0 to River Mile 923.5 (Channel East of Towhead Island)						OSRW	
Livingston, McCracken	Tennessee	Tennessee River	River Mile 22.4 (Kentucky Lake Dam) to River Mile 12.0						OSRW	
Logan	Green	Gasper River	Clear Fork to Wiggington Creek	17.0-35.2		EXC				
Logan	Lower Cumberland	Elk Creek	Tennessee Stateline to Dry Branch	7.5-9.8		EXC				
Logan	Lower Cumberland	Whippoorwill Creek	Mouth to Vicks Branch	0.0-13.0		EXC				
Logan	Lower Cumberland	Whippoorwill Creek	Source to Red River						OSRW	
Lyon	Lower Cumberland	Skinframe Creek	Source to Livingston Creek		CAH					
Madison	Kentucky	Hines Creek	Mouth to Hines Creek Road Crossing	0.0-2.4		EXC				
Madison	Kentucky	Muddy Creek	Elliston, Kentucky to Viney Creek	13.4-20.2		EXC				
Marion	Salt	Salt Lick Creek	Mouth to Headwaters	0.0-8.4		EXC				
Marshall	Tennessee	Clarks River	Persimmon Slough to Middle Fork Creek	26.6-28.4		EXC				

**APPENDIX 16: SPECIAL USE WATERS**

County	Watershed	Water Body	Description	River Mile	CAH	EXC	NWSR	ONRW	OSRW	WR
Marshall	Tennessee	Soldier Creek	Mouth to South Fork Solider	0.0-5.3		EXC				
Martin	Big Sandy	Hobbs Fork	Mouth to Headwaters	0.0-3.8		EXC				
Martin	Big Sandy	Hobbs Fork Unidentified Tributary	Hobbs Fork to Headwaters	0.0-0.55		EXC				
McCracken	Ohio	Massac Creek Unidentified Tributary	Mouth to Headwaters	0.0-1.7		EXC				
McCracken	Ohio	Metropolis	Entire Lake			EXC				
McCracken	Ohio	Metropolis	Entire Lake						OSRW	
McCracken	Ohio	Middle Fork Massac Creek	Hines Road to Headwaters	3.15-6.2		EXC				
McCracken	Ohio	Ohio River	River Mile 940.7 to River Mile 943.3						OSRW	
McCracken	Ohio	West Fork Massac Creek	SR 725 to Little Massac Creek	3.2-5.4		EXC				
McCreary	Upper Cumberland	Beaver Creek	Basin		CAH				OSRW	
McCreary	Upper Cumberland	Beaver Creek	Mouth to Freeman Fork and Middle Fork	0.0-6.5		EXC				
McCreary	Upper Cumberland	Big Branch	Basin Above River Mile 0.8						OSRW	
McCreary	Upper Cumberland	Big South Fork of Cumberland River	Downstream Wild River Boundary to Tennessee Stateline RM 55.2 to 45.0					ONRW	OSRW	WR
McCreary	Upper Cumberland	Cogur Fork	Basin		CAH					
McCreary	Upper Cumberland	Cogur Fork	Mouth to Headwaters	0.0-7.9		EXC				
McCreary	Upper Cumberland	Eagle Creek	Basin						OSRW	
McCreary	Upper Cumberland	Eagle Creek	Mouth to Headwaters	0.0-6.3		EXC				
McCreary	Upper Cumberland	Indian Creek	Laurel fork to Barren Fork	2.3-6.7		EXC				
McCreary	Upper Cumberland	Indian Creek	Source to Barren Fork		CAH					
McCreary	Upper Cumberland	Jennys Branch	Basin						OSRW	
McCreary	Upper Cumberland	Kilburn Fork	Mouth to Headwaters	0.0-6.3		EXC				

**APPENDIX 16: SPECIAL USE WATERS**

County	Watershed	Water Body	Description	River Mile	CAH	EXC	NWSR	ONRW	OSRW	WR
McCreary	Upper Cumberland	Kilburn Fork of Indian Creek	Basin						OSRW	
McCreary	Upper Cumberland	Laurel Creek	Mouth to Laurel Creek Dam	0.0-9.2		EXC				
McCreary	Upper Cumberland	Laurel Creek of Marsh Creek	River Mile 9.0 to River Mile 3.4		CAH				OSRW	
McCreary	Upper Cumberland	Laurel Fork of Indian Creek	Basin						OSRW	
McCreary	Upper Cumberland	Marsh Creek	Basin above River Mile 24.0						OSRW	
McCreary	Upper Cumberland	Marsh Creek	Laurel Creek to Headwaters	8.6-26.2		EXC				
McCreary	Upper Cumberland	Marsh Creek	River Mile 24.0 to Confluence with Cumberland River						OSRW	
McCreary	Upper Cumberland	Mill Creek	Basin						OSRW	
McCreary	Upper Cumberland	Puncheoncamp Branch	Mouth to Headwaters	0.0-1.9		EXC				
McCreary	Upper Cumberland	Rock Creek	Basin from confluence with Jellico Creek						OSRW	
McCreary	Upper Cumberland	Rock Creek	Kentucky/Tennessee State Line (River Mile 21.9) to White Oak Creek		CAH				OSRW	
McCreary	Upper Cumberland	Rock Creek	Tennessee/Kentucky State Line (River Mile 21.9) to White Oak Creek							WR
McCreary	Upper Cumberland	Rock Creek	Tennessee/Kentucky State Line (River Mile 21.9) to White Oak Creek							WR
McCreary	Upper Cumberland	Rock Creek	White Oak Creek to Tennessee Stateline	4.1-21.9		EXC				
McCreary	Upper Cumberland	Rock Creek Unidentified Tributary	Mouth to Headwaters	0.0-1.9		EXC				
McCreary	Upper Cumberland	Rock Creek Unidentified Tributary	Mouth to Headwaters	0.0-1.15		EXC				
McCreary	Upper Cumberland	Shut-in Branch	Basin						OSRW	
McCreary	Upper Cumberland	Trammel Fork	Basin						OSRW	
McCreary	Upper Cumberland	Watts Branch	Mouth to Headwaters	0.0-2.6		EXC				

**APPENDIX 16: SPECIAL USE WATERS**

County	Watershed	Water Body	Description	River Mile	CAH	EXC	NWSR	ONRW	OSRW	WR
McCreary, Whitley	Upper Cumberland	Cumberland River	River Mile 574.6 to River Mile 558.5 (Headwaters of Lake Cumberland) Wild River Boundaries	558.5-574.6		EXC			OSRW	WR
McLean, Ohio	Green	Rough River	River Mile 74.2 to River Mile 73.6		CAH					
Meade	Ohio	Doe Run Creek	Source to Hwy 1628 (River Mile 5.15)		CAH					
Meade	Ohio	Otter Creek	River Mile 9.7 to Ohio River		CAH					
Menifee	Kentucky	East Fork of Indian Creek	Source to Indian Creek		CAH					
Menifee	Kentucky	East Fork of Indian Creek	West Fork of Indian Creek to Headwaters	0.0-8.5		EXC				
Menifee	Kentucky	Gladie Creek	Basin		CAH					
Menifee	Kentucky	Gladie Creek	Mouth to Headwaters	0.0-8.4		EXC				
Menifee	Kentucky	Indian Creek	River Mile 5.2 to River Mile 1.2		CAH					
Menifee	Kentucky	Wolfpen Creek	Mouth to Headwaters	0.0-3.2		EXC				
Menifee	Licking	Botts Fork	Mouth to Landuse Change	0.0-2.1		EXC				
Menifee	Licking	Brushy Fork	Cave Run Lake Backwaters to Headwaters	0.6-5.0		EXC				
Menifee	Licking	Welch Fork	Mouth to First Road Crossing	0.0-1.0		EXC				
Menifee, Wolfe	Kentucky	Red River	River Mile 49.2 - 68.6				NWSR	ONRW	OSRW	WR
Metcalfe	Green	East Fork Little Barren River	Red Lick Creek to Flat Creek	19-20.2		EXC				
Metcalfe	Green	Falling Timber Creek	Landuse Change to Headwaters	7-15.5		EXC				
Monroe	Upper Cumberland	Cumberland River	River Mile 460.9 (Lake Cumberland Dam) to Kentucky/Tennessee State Line (River Mile 401.05)		CAH					
Monroe	Upper Cumberland	McFarland Creek	Little McFarland Creek to Spring Branch	0.8-6.2		EXC				
Monroe	Upper Cumberland	Meshack Creek	Mouth to Headwaters	0.0-2.8		EXC				
Monroe, Cumberland	Upper Cumberland	Mud Camp Creek	Unidentified Tributary to Headwaters	3.7-8.4		EXC				
Morgan	Licking	Blackwater Creek	Eaton Creek to Greasy Fork	3.8-11.4		EXC				
Morgan	Licking	Bucket Branch	Mouth to Headwaters	0.0-1.9		EXC				
Morgan	Licking	Devils Fork	Mouth to Headwaters	0.0-7.8		EXC				
Morgan	Licking	North Fork of Licking River	Cave Run Lake Backwaters to Devils Fork	9.9-14.2		EXC				

**APPENDIX 16: SPECIAL USE WATERS**

County	Watershed	Water Body	Description	River Mile	CAH	EXC	NWSR	ONRW	OSRW	WR
Morgan, Rowan	Licking	Minor Creek	River Mile 2.0 to Craney Creek		CAH					
Ohio	Green	Halls Creek	Unidentified Tributary to Headwaters	9.6-12.1		EXC				
Ohio	Green	Muddy Creek	Landuse Change to Headwaters	13.0-15.5		EXC				
Ohio	Green	Sixes Creek	Wild Branch to Headwaters	2.0-7.5		EXC				
Ohio, Grayson	Green	Rough River	River Mile 89.3 (Rough River Lake Dam) to River Mile 88.5		CAH					
Owen	Kentucky	Cedar Creek Unidentified Tributary	Mouth to Headwaters	0.0-1.4		EXC				
Owen	Kentucky	Mill Creek	Mouth to Headwaters	0.0-8.3		EXC				
Owen	Kentucky	Severn Creek	Mouth to North Fork Severn Creek	0.0-2.8		EXC				
Owsley	Kentucky	Buffalo Creek	Mouth to Right Fork and Left Fork	0.0-1.6		EXC				
Owsley	Kentucky	Right Fork of Buffalo Creek	Mouth to Headwaters	0.0-11.2		EXC				
Owsley	Kentucky	South Fork of Kentucky River	Mouth to Sexton Creek	0.0-27.7		EXC				
Pendleton	Licking	Brushy Fork	Mouth to Headwaters	0.0-5.7		EXC				
Pendleton	Licking	Grovers Creek	Kincaid Lake Backwaters to Unidentified Tributary	0.5-3.4		EXC				
Pendleton	Licking	South Fork Grassy Creek	Mouth to Greasy Creek	0.0-19.6		EXC				
Pike	Big Sandy	Lower Pigeon Branch	Left Fork to Headwaters	0.5-1.7		EXC				
Pike	Big Sandy	Russell Fork	Clinch Field RR Yard off HWY 80 to Virginia Stateline	14.4-16		EXC				
Pike	Big Sandy	Toms Branch	Mouth to Headwaters	0.0-1.4		EXC				
Powell	Kentucky	Hardwick Creek	Mouth to Little Hardwick Creek	0.0-3.2		EXC				
Powell	Kentucky	Middle Fork of Red River	Source to River Mile 10.6		CAH					
Powell	Kentucky	Middle Fork of Red River	South Fork Red River to Natural Bridge State Park Lake	1.8-8.3		EXC				
Powell	Kentucky	South Fork of Red River	Mouth to Sandlick Fork	0.0-3.9		EXC				
Pulaski	Upper Cumberland	Bee Lick Creek	Mouth to Unidentified Tributary	0.0-5.7		EXC				
Pulaski	Upper Cumberland	Big Lick Branch	Basin						OSRW	
Pulaski	Upper Cumberland	Brushy Creek	Mouth to Headwaters	0.0-16.0		EXC				



### APPENDIX 16: SPECIAL USE WATERS

County	Watershed	Water Body	Description	River Mile	CAH	EXC	NWSR	ONRW	OSRW	WR
Pulaski	Upper Cumberland	Buck Creek	Lake Cumberland Backwaters to Headwaters	5.0-62.6		EXC				
Pulaski	Upper Cumberland	Buck Creek	River Mile 53.3 to River Mile 10.5						OSRW	
Pulaski	Upper Cumberland	Clifty Creek	Mouth to Rocky Branch	0.0-2.7		EXC				
Robertson	Licking	West Creek	Mouth to Headwaters	0.0-9.5		EXC				
Rockcastle	Upper Cumberland	Brush Creek	Wolf Creek to Reemergence of Sinking Creek	1.1-7.6		EXC				
Rockcastle	Upper Cumberland	Roundstone Creek	River Mile 13.5 to River Mile 4.7						OSRW	
Rockcastle	Upper Cumberland	South Fork of Rockcastle River	River Mile 2.1 to Rockcastle River						OSRW	
Rowan	Licking	Craney Creek	Mouth to Headwaters	0.0-10.0		EXC				
Rowan	Licking	Slabcamp Creek	Basin including Stonecoal Branch		CAH					
Rowan	Licking	Slabcamp Creek	Mouth to Headwaters	0.0-3.4		EXC				
Rowan, Morgan	Licking	Craney Creek	Source to North Fork of Licking River		CAH					
Shelby	Kentucky	Indian Fork	Mouth to Headwaters	0.0-3.3		EXC				
Shelby	Salt	Brashears Creek	Guist Creek to Bullskin and Clear Creek	13.0-25.5		EXC				
Simpson	Green	Lick Creek	Mouth to Headwaters	0.0-9.9		EXC				
Simpson	Green	Lick Creek	Source to West Fork of Drakes Creek		CAH					
Simpson	Lower Cumberland	Sulphur Spring Creek	Source to Red River		CAH					
Spencer	Salt	Guist Creek	Mouth to Jephtha Creek	0.0-15.4		EXC				
Todd	Green	Clifty Creek	Little Clifty Creek to Sulphur Lick	7.7-13.2		EXC				
Trigg	Lower Cumberland	Casey Creek	Source to Little River		CAH					
Trigg	Lower Cumberland	Crooked Creek	Lake Barkley Backwaters to Headwaters	4.0-9.4		EXC				
Trigg	Lower Cumberland	Donaldson Creek	Craig Branch to Unidentified Tributary	6.9-10.3		EXC				
Trimble	Ohio	Corn Creek Unidentified Tributary	Mouth to Headwaters	0.0-2.0		EXC				
Union	Ohio	Ohio River	River Mile 848.0 to River Mile 850.0						OSRW	
Union	Ohio	Ohio River	River Mile 859.0 to River Mile 861.0						OSRW	
Union	Ohio	Ohio River	River Mile 865.0 to River Mile 867.0						OSRW	
Warren	Green	Little Beaverdam Creek	Mouth to SR 743	0.0-11.3		EXC				

**APPENDIX 16: SPECIAL USE WATERS**

County	Watershed	Water Body	Description	River Mile	CAH	EXC	NWSR	ONRW	OSRW	WR
Washington	Salt	Chaplin River	Thompson Creek to Cornishville, KY	40.1-53.7		EXC				
Wayne	Upper Cumberland	Kennedy Creek	River Mile 1.0 to Little South Fork of Cumberland River						OSRW	
Wayne	Upper Cumberland	Little South Fork of Cumberland River	Mouth to Langham Branch	0.0-35.6		EXC				
Wayne	Upper Cumberland	Little South Fork of Cumberland River	River Mile 35.6 to River Mile 4.1						OSRW	
Wayne	Upper Cumberland	Otter Creek	Lake Cumberland Backwaters to Carpenter Fork	14.5-22.0		EXC				
Wayne, McCreary	Upper Cumberland	Little South Fork of Cumberland River	River Mile 14.5 to River Mile 4.1							WR
Wayne, McCreary	Upper Cumberland	Little South Fork of Cumberland River	River Mile 14.5 to River Mile 4.1							WR
Whitley	Upper Cumberland	Adams Branch	Basin						OSRW	
Whitley	Upper Cumberland	Archers Creek	Basin						OSRW	
Whitley	Upper Cumberland	Bark Camp Creek	Basin		CAH					
Whitley	Upper Cumberland	Bark Camp Creek	Mouth to Martins Fork	0.0-3.95		EXC				
Whitley	Upper Cumberland	Buck Creek	Basin						OSRW	
Whitley	Upper Cumberland	Bucks Branch	Basin						OSRW	
Whitley	Upper Cumberland	Buffalo Creek	Basin to Kentucky/Tennessee State Line (River Mile 3.2)						OSRW	
Whitley	Upper Cumberland	Bunches Creek	Basin	0.0-3.3	CAH	EXC			OSRW	
Whitley	Upper Cumberland	Campbell Branch	Basin						OSRW	
Whitley	Upper Cumberland	Criscillis Branch	Basin						OSRW	
Whitley	Upper Cumberland	Dog Slaughter Creek	Basin		CAH				OSRW	
Whitley	Upper Cumberland	Dog Slaughter Creek	Mouth to North Fork and South Fork	0.0-1.1		EXC				

### APPENDIX 16: SPECIAL USE WATERS

County	Watershed	Water Body	Description	River Mile	CAH	EXC	NWSR	ONRW	OSRW	WR
Whitley	Upper Cumberland	Jackie Branch	Mouth to Headwaters	0.0-1.7		EXC				
Whitley	Upper Cumberland	Laurel Fork	Tennessee Stateline to Tiny Branch/Pine Creek	4.2-13.0		EXC				
Whitley	Upper Cumberland	Laurel Fork of Clear Fork	River Mile 16.0 to River Mile 4.25 (Kentucky/Tennessee State Line)						OSRW	
Whitley	Upper Cumberland	Mud Creek	Basin above River Mile 6.5						OSRW	
Whitley	Upper Cumberland	Patterson Creek	Basin above River Mile 7.4						OSRW	
Whitley	Upper Cumberland	Ross Branch	Basin						OSRW	
Whitley	Upper Cumberland	Ryans Creek	Basin						OSRW	
Whitley	Upper Cumberland	Sanders Creek	Basin						OSRW	
Whitley	Upper Cumberland	South Fork of Dog Slaughter Creek	Mouth to Headwaters	0.0-4.6		EXC				
Whitley	Upper Cumberland	Tyes Fork of Bennetts Fork	Basin						OSRW	
Whitley	Upper Cumberland	Youngs Creek	Basin						OSRW	
Wolfe	Kentucky	Chester Creek	Mouth to Headwaters	0.0-2.8		EXC				
Wolfe	Kentucky	Chimney Top Creek	Basin		CAH					
Wolfe	Kentucky	Dog Fork	Basin		CAH					
Wolfe	Kentucky	Mill Creek	Entire Reservoir		CAH					
Wolfe	Kentucky	Parched Corn Creek	Source to Red River		CAH					
Wolfe	Kentucky	Swift Camp Creek	Source to Red River		CAH					
Woodford	Kentucky	Clear Creek	Mouth to East Fork Clear Creek	0.0-8.8		EXC				
Woodford	Kentucky	Glenns Creek Unidentified Tributary	Landuse Change to Headwaters	0.2-1.3		EXC				
Woodford	Kentucky	Griens Creek	Urban Area to Unidentified Tributary	2.9-3.4		EXC				

## APPENDIX 16: DRINKING WATER SOURCES

County	PWS ID	Owner	Source Name	Intake Location	Source Type	Availability
Adair	10082	Columbia Utilities Commission	Green River Reservoir	Surface Water Intake Located at River Mile 316.2r of Green River (Green River Reservoir)	Reservoir	Permanent
Adair	10082	Columbia Utilities Commission	Russell Creek	Withdrawals at River Mile 41.92 of Russell Creek	Creek	Permanent
Allen	21006	Calvert Spring Water Company	Calvert Springs		Spring	Permanent
Allen	50929	Glasgow Water Company	Barren Lake	Intake Located in Barren River Reservoir at Barren River Mile 86.8r, Barren County	Lake	Permanent
Allen	20386	Scottsville Water Department	Barren River Reservoir	Surface Water Intake Located at Mile 91.7 of the Barren River (Barren River Lake)	Reservoir	Permanent
Anderson	30239	Lawrenceburg Water & Sewer Department	Kentucky River	Kentucky River, Approximately 1000 Feet Downstream From Blackburn Memorial Bridge on Highway 62, Approximately 2 Miles East of Lawrenceburg (River Mile 83.75)	River	Permanent
Barren	50929	Glasgow Water Company	Beaver Creek	Intake Located in Beaver Creek	Creek	Permanent
Bath	1030292	Morehead Utility Plant Board	Licking River	Surface Intake Located at River Mile 170.6 of the Licking River	River	Permanent
Bath	60338	Owingsville Water & Sewage	Slate Creek	Surface Water Intake Located at River Mile 17.0 of Slate Creek	Creek	Permanent
Bell	70729	Bell County Forest Camp	Cheona Lake	Withdrawal From Cheona Lake	Lake	Permanent
Bell	70353	City Of Pineville	Cannon Creek Lake	Surface Intake at River Mile 3.2 of Cannon Creek, Bell County.	Lake	Permanent
Bell	70734	Henderson Settlement	Henderson Settlement Reservoir	Withdrawal From Pine Creek	Reservoir	Permanent
Bell	70282	Us Utilities	Fern Lake	Surface Water Intake Located in Fern Lake, An Impoundment at River Mile 3.2	Lake	Permanent
Boone	82026	Big Bone Lick State Park #1	Big Bone Lick Lake	Withdrawal From Big Bone Lick Lake on the Western Bank.	Lake	Permanent
Bourbon	90287	Millersburg Municipal Water Works	Hinkston Creek	Withdrawal From Hinkston Creek Opposite River Mile 78.1r, Bourbon County.	Creek	Permanent
Bourbon	90343	Paris Water Works	Stoner Creek	Surface Intake Located on Stoner Creek Opposite River Mile 16.59l, Bourbon Co.	Creek	Permanent

## APPENDIX 16: DRINKING WATER SOURCES

County	PWS ID	Owner	Source Name	Intake Location	Source Type	Availability
Boyd	100011	Ashland Water Works	Ohio River	Surface Water Intake Located at River Mile 661.72 (River Mile 319.68 Bp) of the Ohio River	River	Permanent
Boyle	110097	Danville City Water Works	Herrington Lake	Withdrawal From Dix River Opposite Mile 18.60l (Herrington Lake), Boyle Co.	Lake	Permanent
Boyle	110664	North Point Training Center	Lake Herrington	Surface Withdrawal From Herrington Lake Approx. 4 Miles North of Danville, Boyle Co.	Lake	Permanent
Breathitt	130208	Jackson Municipal Water Works	North Fork Kentucky River	Withdrawal From North Fork Kentucky River Opposite River Mile 305.45l, Breathitt	River	Permanent
Butler	160052	Butler County Water System, Inc	Green River	Surface Water Intake Located at River Mile 142.17 of the Green River	River	Permanent
Butler	160294	Morgantown Water System	Green River	Surface Intake on the Left Bank of the Green River at River Mile 143.27	River	Permanent
Caldwell	540958	Dawson Springs Municipal Waterworks & Sewer System	Lake Beshear	Surface Water Intake Located Above the Dam of Lake Beshear, An Impoundment at River Mile 0.1 of Piney Creek	Lake	Permanent
Caldwell	1170361	Providence Water Works	Tradewater River	Surface Intake Located at River Mile 40.8 of the Tradewater River	River	Permanent
Campbell	190313	Newport Water Works	Ohio River	Transfer of Water From Ohio River Opposite Mi. 518.0 To 2 Storage Basins	River	Permanent
Campbell	590220	Northern Kentucky Water District	Ohio River	Surface Water Intake Located at River Mile 518.7 (462.7 Bp) of the Ohio River - Plant B	River	Permanent
Carter	220164	Grayson Utility Commission	Little Sandy River	Surface Water Intake Located at River Mile 39.03 of the Little Sandy River	River	Permanent
Carter	220335	Olive Hill Municipal Water Works	Tygarts Creek	Surface Water Intake Located at River Mile 78.9 of Tygarts Creek	Creek	Emergency
Carter	220335	Olive Hill Municipal Water Works	Olive Hill Reservoir	Surface Water Intake Located in the Oliver Hill Reservoir, An Impoundment At River Mile 2.2 of Perry Branch	Reservoir	Permanent
Casey	230987	Liberty Water & Gas	Lake Liberty	Surface Water Intake Located Approximately 0.1 River Miles Upstream of the Lake Liberty Dam, Which Impounds Hickman Creek at River Mile 1.4	Lake	Permanent
Christian	240090	Hopkinsville Water Environment Authority	Lake Manire	Surface Water Intake Located at the Dam of Lake Manire	Lake	Permanent

### APPENDIX 16: DRINKING WATER SOURCES

County	PWS ID	Owner	Source Name	Intake Location	Source Type	Availability
Christian	240201	Hopkinsville Water Environment Authority	Stone Quarry #2	Intake Located in Hopkinsville Stone Quarry No. 2 (North Quarry)	Mine	Permanent
Christian	240201	Hopkinsville Water Environment Authority	N Fork Little River	Intake Located in Hopkinsville Stone Quarry No. 2 (North Quarry)	River	Permanent
Christian	240201	Hopkinsville Water Environment Authority	Stone Quarry #1	Intake Located in the Hopkinsville Stone Quarry No. 1 (South Quarry)	Mine	Permanent
Christian	240329	Oak Grove Water Department	Hunter Spring	W/D From Hunter Spring, Adjacent To Mi. 16.65 West Fork Red River, Christian Co. - An Interim Authorization Issued 12/3/96 (Indefinite Expiration Date) For 0.500 MGD.	Spring	Permanent
Clark	250473	Winchester Municipal Utilities Commission	Winchester Reservoir	Surface Water Intake Located at River Mile 176.51 of the Kentucky River, Pool # 10. Plant Capacity: Currently, 5.0 MGD Gradually Increasing To 12 MGD.	Reservoir	Permanent
Clark	250473	Winchester Municipal Utilities Commission	Kentucky River	Surface Water Intake Located at River Mile 176.51 of the Kentucky River, Pool # 10. Plant Capacity: Currently, 5.0 MGD However Gradually Increasing To 12 MGD.	River	Permanent
Clay	260737	City Of Manchester	Goose Creek	Surface Water Intake Located at River Mile 19.5 of Goose Creek - Interim Authorization	Creek	Permanent
Clay	260737	City Of Manchester	Bert Combs Lake	Surface Water Intake Located at River Mile 19.5 of Goose Creek - Interim Authorization	Lake	Permanent
Clinton	270003	Albany Municipal Water & Sewer	Lake Cumberland	Surface Water Intake Located at River Mile 7.0 of Indian Creek (Lake Cumberland )	Lake	Permanent
Clinton	270003	Albany Municipal Water & Sewer	Lake Cumberland	Surface Water Intake	Lake	Permanent
Crittenden	280267	Marion Water Department	Lake George	Withdrawal From Crooked Ck at River Mile 25.6 (City Lake) & Tributary To Crooked Ck at River Mile 0.55 (Lake George), Crittenden Co.	Lake	Permanent
Crittenden	280267	Marion Water Department	City Lake		Lake	Permanent
Cumberland	290049	Burkesville Municipal Water Works	Cumberland River	Withdrawal From the Cumberland River Opposite River Mile 427.05r, Cumberland Co.	River	Permanent

## APPENDIX 16: DRINKING WATER SOURCES

County	PWS ID	Owner	Source Name	Intake Location	Source Type	Availability
Cumberland	290271	Cumberland County Water District	Cumberland River	Surface Water Intake Located at River Mile 419.68 of the Cumberland River	River	Permanent
Edmonson	310114	Edmonson County Water District	Green River	Withdrawals From the Green River at River Mile 181.32	River	Permanent
Estill	330205	Irvine Municipal Utilities Commission	Kentucky River Pool 11	Withdrawal From Kentucky River Pool #11 Opposite River Mile 218.5r.	River	Permanent
Fayette	340250	Kentucky-American Water Company	E Hickman Creek Reservoir #4	Withdrawal From East Hickman Creek Opposite River Mile 10.35r (Reservoir No. 4).	Reservoir	Permanent
Fayette	340250	Kentucky-American Water Company	W Hickman Reservoir #1	Withdrawal From East Hickman Creek Opposite River Mile 10.35r (Reservoir No. 4).	Reservoir	Emergency
Fayette	340250	Kentucky-American Water Company	Kentucky River Pool 9	Withdrawal From Pool #9 of the Kentucky River Opposite River Mile 167.43r	River	Permanent
Fleming	350134	Flemingsburg Utility System	Flemingsburg Lake	Surface Water Intake Located Within Flemingsburg Lake at Stream Mile 0.7r of A Tributary of Town Branch (Plant Capacity 7/21/97 - 0.720 MGD)	Lake	Permanent
Floyd	360152	Francis Water Company	Francis Water Mine Well	Mine Next To Francis Water Treatment Plant	Mine	Permanent
Floyd	360358	Prestonsburg City Utilities Commission	Levisa Fork Big Sandy River	Surface Water Intake Located at River Mile 84.3r of the Levisa Fork of the Big Sandy River	River	Permanent
Floyd	360026	Southern Water & Sewer District	Levisa Fork Big Sandy River	Surface Water Intake Located at River Mile 92.0 of the Levisa Fork For the Big Sandy River	River	Permanent
Floyd	360463	Wheelwright Utilities Commission	Wheelwright Mine	Site #1 - Wheelwright Mine Which Is Between Jacks Creek And Right Fork Otter Creek	Mine	Permanent
Franklin	370143	Frankfort Electric & Water Plant Board	Kentucky River Pool 4	Surface Water Intake Located at River Mile 69.8 of the Kentucky River, Pool #4	River	Permanent
Garrard	400233	Lancaster Water Works	Reservoir #1	Withdrawal From Kentucky River 141.62l, Immediately Below the Mouth of Davi	Reservoir	Permanent
Garrard	400233	Lancaster Water Works	Kentucky River Pool 8	Withdrawal From Kentucky River 141.62l, Immediately Below the Mouth of Davis Creek, Pool #8	River	Permanent
Grant	410047	Bullock Pen Water District	Bullock Pen Lake	Surface Intake Located in Bullock Pen Lake at River Mile 2.8 of Bullock Pen Creek, Off Highway 1548	Lake	Permanent
Grant	410472	Williamstown Municipal Water Department	Williamstown Lake	Withdrawal From Lake Branch at River Mile 1.89 (Lake Williamstown), Grant County.	Lake	Permanent

### APPENDIX 16: DRINKING WATER SOURCES

County	PWS ID	Owner	Source Name	Intake Location	Source Type	Availability
Grayson	430063	Caneyville Municipal Water Works	Caneyville Reservoir	Withdrawal From Bennett Fork of Caney Creek Opposite Mile 1.3r (Caneyville Reservoir), Grayson County.	Reservoir	Permanent
Grayson	430244	Leitchfield Water Works	Rough River Reservoir	Withdrawal From the Rough River Opposite Mile 107.42l (Reservoir), Grayson County.	Reservoir	Permanent
Green	440168	Greensburg Water Department	Green River	Surface Intake Located at River Mile 279.8r of Green River, Green County.	River	Permanent
Greenup	450169	Greenup Water Department	Little Sandy River	Surface Water Intake Located at River Mile 0.7 of the Little Sandy River	River	Permanent
Greenup	450376	Russell Water Works	Ohio River	Intake Located on South Bank of Ohio River at Mile 327.7 Bp,3000ft Down Stream From Toll Bridge at Russell, Kentucky	River	Permanent
Hardin	470118	Elizabethtown Water Department	Freeman Lake	5 Wells: #1-#2-#3 at Water Plant/River Mile 9.62, 9.72,& 9.8 of Valley Creek; #4 at River Mile 9.0; #5 at River Mile 8.7 Valley Creek	Lake	Permanent
Hardin	470118	Elizabethtown Water Department	Gaithers Station Spring	5 Wells: #1-#2-#3 at Water Plant/River Mile 9.62, 9.72,& 9.8 of Valley Creek; #4 at River Mile 9.0; #5 at River Mile 8.7 Valley Creek	Spring	Permanent
Hardin	470118	Elizabethtown Water Department	Dyers Spring (Old City)	Behind City Springs Water Treatment Plant	Spring	Permanent
Hardin	470393	Hardin County Water District #1	Pirtle Spring		Spring	Permanent
Hardin	470393	Hardin County Water District #1	Head Of Rough River		Spring	Permanent
Hardin	470175	Hardin County Water District #2	Nolin River	Surface Water Intake Located at the Confluence of White Mills Spring And the Nolin River, at River Mile 80.4	River	Permanent
Harlan	480565	Cawood Water District	Martins Fork Cumberland River	Surface Intake Located at Mile 10.1 of the Martins Fork of the Cumberland River	River	Permanent
Harlan	480028	City Of Benham	Mine	Intake in Stream Flowing From Under Ground Mine 1000 Ft Southwest of Benham Ky. 70	Mine	Permanent
Harlan	480092	City Of Cumberland	Poor Fork Cumberland River	Surface Water Intake Opposite Poor Fork of Cumberland River River Mile 719.57r.	River	Permanent
Harlan	480125	City Of Evarts	Mine	Withdrawal From Abandoned Mine	Mine	Emergency



### APPENDIX 16: DRINKING WATER SOURCES

County	PWS ID	Owner	Source Name	Intake Location	Source Type	Availability
Harlan	480178	City Of Harlan	Poor Fork Cumberland River	Surface Intake Located at River Mile 694.36l of Poor Fork, Harlan County.	River	Permanent
Harlan	480262	City Of Lynch	Abandoned Mine #31	Intake Located in An Underground Storage Reservoir (Apogee Coal Company)	Mine	Permanent
Harlan	480341	Green Hills Water District	Cold Spring	Spring Located Near Nally & Gibson's Quarry, Adjacent To Us Hwy 421 And H	Spring	Permanent
Harlan	482399	Kingdom Come State Park	Small Lake	Withdrawal From Small Lake	Lake	Permanent
Harrison	490096	Cynthiana Municipal Water Works	South Fork Licking River	Surface Water Intake Located at River Mile 50.41 of the South Fork of the Licking River - Cynthiana Quad	River	Permanent
Harrison	490096	Cynthiana Municipal Water Works	Licking River	Withdrawals From River Mile 83.1 of the Licking River	River	Reserve
Hart	430245	Edmonson County Water District/Wax Plant	Nolin Reservoir	Surface Water Intake Located at Mile 28.01 of the Nolin River (Nolin Reservoir)	Reservoir	Permanent
Hart	500166	Green River Valley Water District	Green River	Intake Site at River Mile 237.0 of the Green River.	River	Permanent
Hart	500166	Green River Valley Water District	Rio Verde Spring	Rio Springs Located 2000 ft Northwest of Mouth of Rocky Hollow on Green River Cave City, Kentucky	Spring	Permanent
Henderson	510188	Henderson Water Utilities North	Ohio River	Ohio River, River Mile 803.6	River	Permanent
Hopkins	540108	Earlington Water & Sewer Department	Loch Mary Reservoir	Intake Located on Loch Mary Reservoir on the Western City Boundary of Earlington, Ky.	Reservoir	Permanent
Hopkins	540936	Madisonville Light & Water	Pee Wee Lake	Intake Located at Green River River Mile 54.0l	Lake	Permanent
Hopkins	540936	Madisonville Light & Water	Grapevine Lake	Intake Located at Mouth of Grapevine Lake	Lake	Reserve
Hopkins	540936	Madisonville Light & Water	City Park Lakes #1	Intake Located at Mouth of Lake #3	Lake	Permanent
Hopkins	540936	Madisonville Light & Water	Green River	Intake Located Se Corner of Lake Pewee Dam, 1mi. North East of Madisonville, Kentucky	River	Reserve
Jackson	550784	City Of Mckee	Mckee City Reservoir	Surface Water Intake Located in the Mckee City Reservoir, An Impoundment	Reservoir	Permanent
Jackson	550209	Jackson County Water Association	Beulah Tyner Lake	Surface Water Intake Located in Beulah (Tyner) Lake	Lake	Permanent

### APPENDIX 16: DRINKING WATER SOURCES

County	PWS ID	Owner	Source Name	Intake Location	Source Type	Availability
Jefferson	560258	Louisville Water Company	Ohio River	Surface Water Intake Located at River Mile 594.65l of the Ohio River at the B.E. Payne Water Treatment Plant	River	Permanent
Jefferson	560258	Louisville Water Company	Ohio River	Withdrawal From Ohio River Opposite River Mile 380.8l(600.6 Bp), Jefferson Co.	River	Permanent
Jessamine	570495	Highbridge Spring Water Co	High Bridge Spring		Spring	Permanent
Jessamine	570315	Nicholasville Utilities	Kentucky River Pool 8	Withdrawal From Kentucky River Opposite River Mile 154.1r, Pool #8	River	Permanent
Jessamine	570010	Wilmore Water Works	Kentucky River Pool 6	Withdrawal From Kentucky River Opposite River Mile 114.0r, Pool #6	River	Permanent
Johnson	580340	Paintsville Utility Commission	Levisa Fork Big Sandy River	Withdrawal From the Levisa Fork of the Big Sandy River Opposite River Mile 65.44l	River	Permanent
Kenton	590220	Northern Kentucky Water District	Licking River	Surface Water Intake Located at River Mile 4.55(l) of the Licking River - Plant A	River	Permanent
Knox	610016	Barbourville Utility Commission	Cumberland River	Withdrawal From the Cumberland River	River	Permanent
Knox	610110	Knox County Utility Commission	Cumberland River	Withdrawal From the Cumberland River Opposite River Mile 642.6l, Knox County. (As	River	Permanent
Larue	620200	Hodgenville Water Works	North Fork Nolin River	Surface Intake Located at 114.7l of the North Fork of the Nolin River, Larue County	River	Permanent
Laurel	610016	Barbourville Utility Commission	Laurel River Lake	Laurel River Lake, Adjacent To River Mile 1.35r of Indian Camp Creek	Lake	Permanent
Laurel	1180085	City Utilities Commission	Laurel River	Withdrawal from Laurel River Approximately at River Mile 21.45l (City Reservoir), Laurel Co.	River	Permanent
Laurel	630238	Laurel County Water District #2	Laurel River	Surface Water Intake Located at Mile 27.95l of the Laurel River Above the	River	Permanent
Laurel	630255	London Utility Commission	City Of London Reservoir	Withdrawal From City of London Reservoir	Reservoir	Emergency
Laurel	630255	London Utility Commission	Laurel River Lake	Withdrawal From Indian Camp Creek (Laurel River Reservoir) Opposite Mile 1.	Lake	Permanent
Laurel	630477	Wood Creek Water District	Wood Creek Lake	Surface Water Intake Located in Wood Creek Lake, An Impoundment at Mile 7	Lake	Permanent
Lawrence	640257	Louisa Board Of Water And Sewer Commission	Levisa Fork Big Sandy River	Surface Water Intake Located at Mile 27.35 of the Levisa Fork of the Big Sandy River, Approximately 2000 Feet Upstream of the Confluence With the Tug Fork	River	Permanent

### APPENDIX 16: DRINKING WATER SOURCES

County	PWS ID	Owner	Source Name	Intake Location	Source Type	Availability
Lee	650024	Beattyville Water Works	North Fork Kentucky River Pool 14	Surface Water Intake Located at Mile 256.05 of the North Fork of the Kent	River	Permanent
Leslie	660204	Hyden Leslie Co Water Dist	Middle Fork Kentucky River	Surface Water Intake Located on the Middle Fork Kentucky River at River Mile 76.	River	Permanent
Letcher	670462	Blackey Water System	Kentucky River	Surface Water Intake Located in the North Fork of the Kentucky River	River	Permanent
Letcher	670279	Fleming-Neon Water Company	Shea Fork Mine	W/D From Deep Mine Well Located at N37 13' 05" & W82 41' 11", Letcher Co.	Mine	Permanent
Letcher	670213	Jenkins Water System	Lake 203	One Well W/Drawing From Abandoned Mine #207 at River Mile 27.5 of Elkhorn Creek	Lake	Permanent
Letcher	670466	Whitesburg Municipal Water Works	N Fork Kentucky River	Surface Water Intake Located at Mile 406.3 of the North Fork of the Kentucky River	River	Permanent
Lincoln	690417	Stanford Water Commission	Rice Lake	Surface Water Intake Located in Rice Lake (Stanford City Lake), An Impoundment at Mile 5.63 of Neals Creek.	Lake	Permanent
Lincoln	690417	Stanford Water Commission	James C Harris Reservoir	Surface Water Intake Located in the James C. Harris Reservoir, An Impoundment at Mile 0.8 of Hubert Miracle Creek. Plant Capacity: 0.900 MGD	Reservoir	Permanent
Lincoln	690417	Stanford Water Commission	Buck Creek		Lake	
Livingston	700532	Crittenden-Livingston County Water District	Cumberland River	Withdrawal From the Cumberland River at Mile 15.95, Livingston Co.	River	Permanent
Livingston	700162	Grand Rivers Water System	Kentucky Lake		Lake	Other
Logan	710001	Adairville Water Works	South Fork Red River	Surface Water Intake Located at River Mile 5.42 of the South Fork of the Red River	River	Permanent
Logan	710012	Auburn Water Department	Black Lick Creek	Spring Located Adjacent To the Water Treatment Plant, Approximately 800 Feet South of Us Hwy 68, in Auburn	Creek	Permanent
Logan	710247	Lewisburg Water Works	Spa Lake	Surface Water Intake Located in Spa Lake, An Impoundment at Mile 18.85 of Wolf Lick Creek	Lake	Permanent
Logan	712042	Logan Aluminum Inc	Spa Lake		Lake	Permanent
Logan	710378	Russellville Municipal Water System	Lake Herndon	Surface Water Intake Located in Lake Herndon, An Impoundment of Edger Creek	Lake	Permanent

### APPENDIX 16: DRINKING WATER SOURCES

County	PWS ID	Owner	Source Name	Intake Location	Source Type	Availability
Lyon	720113	Eddyville Water Department	Lake Barkley	Withdrawal From Knob Creek Branch (Lake Barkley) Opposite Mile 0.611, Lyon County.	Lake	Permanent
Lyon	720552	Kentucky State Penitentiary	Kentucky Lake	20 Ft From Shoreline in Front of the Plant	Lake	Permanent
Lyon	720227	Kuttawa Water Department	Lake Barkley		Lake	Permanent
Lyon	170360	Princeton Water & Wastewater Commission	Lake Barkley	Surface Water Intake Located at Mile 46.0r of the Cumberland River, Lake Barkley (Plant Capacity 7/21/97 - 2.0 MGD)	Lake	Permanent
Madison	760030	Berea College Water Department	Cowbell Lake	Surface Water Intake Located in Cowbell Lake, An Impoundment of Cowbell Creek	Lake	Permanent
Madison	760030	Berea College Water Department	Owsley Fork Lake	Surface Water Intake Located in Owsley Fork Lake, An Impoundment of Owsley Fork of Redlick Creek	River	Permanent
Madison	760030	Berea College Water Department	Lower Silver Creek Lake	Surface Water Intake Located in Upper Silver Creek Lake (Kales Lake), An Impoundment of East Fork of Silver Creek	Creek	Permanent
Madison	760030	Berea College Water Department	Owsley Fork		Reservoir	Permanent
Madison	760370	Richmond Water, Gas & Sewer	Kentucky River Pool 11	Surface Water Intake Located at Mile 201.33 of the Kentucky River (Pool 1)	River	Permanent
Marion	780241	Lebanon Water Works Company Inc	Rolling Fork River	Surface Water Intake Located at Mile 98.25 of the Rolling Fork River - Lebanon West Quad	River	Permanent
Marion	780241	Lebanon Water Works Company Inc	Rolling Fork River	Surface Water Intake Located at Mile 98.25 of the Rolling Fork River - Lebanon West Quad	River	Permanent
Marion	780241	Lebanon Water Works Company Inc	Rolling Fork River	Surface Water Intake Located at Mile 98.25 of the Rolling Fork River - Lebanon West Quad	River	Permanent
Marion	780241	Lebanon Water Works Company Inc	Fagan Branch Reservoir	Surface Water Intake Located in Fagan Branch Reservoir, An Impoundment at Mile 2.0 of Fagan Branch - Lebanon East Quad	Reservoir	Permanent
Martin	800273	Martin County Water District	Tug Fork Big Sandy River	Surface Water Intake Located at Mile 23.5 of the Tug Fork of the Big Sand Y River - Secondary Intake - Water Pumped From This Intake To the Curtis Cr Um Reservoir	River	Permanent

### APPENDIX 16: DRINKING WATER SOURCES

County	PWS ID	Owner	Source Name	Intake Location	Source Type	Availability
Martin	800273	Martin County Water District	Curtis Crum Reservoir	Surface Water Intake Located in Curtis Crum Reservoir, An Impoundment at Mile 1.2 of Lick Branch - Primary Intake - Water Pumped From Tug Fork to the Curtis Crum Reservoir	Reservoir	Permanent
Mason	810275	Maysville Utility Commission	Ohio River	Surface Water Intake Located at Mile 573.45 (408.5 Bp) of the Ohio River	River	Permanent
McClellan	750055	Calhoun Water Works	Green River	Surface Intake Located at Mile 63.55r of Green River, McClellan County.	River	Permanent
McCracken	730533	Paducah Water Works	Ohio River	Surface Water Intake Located at Mile 45.8 (935.6 Bp) of the Ohio River	River	Permanent
McCreary	740276	McCreary County Water District	Laurel Creek Reservoir	Withdrawals From Laurel Creek Reservoir, An Impoundment at Mile 8.9 of Laurel Creek.	Reservoir	Permanent
Mclean	750252	Livermore Water Works	Green River	Surface Intake Located on Green River Opposite Mile 71.28r, Mclean County	River	Permanent
Meade	820041	Brandenburg Water Works	Ohio River		River	Unknown
Meade	820041	Brandenburg Water Works	Ohio River		River	Unknown
Meade	820641	Doe Valley Utilities Inc	Doe Valley Lake	Intake Located in Doe Valley Lake (Reservoir), Mile 1.62 of Doe Run, Meade County	Lake	Permanent
Mercer	840180	Harrodsburg Municipal Water Department	Kentucky River Pool #7	Two Adjacent Surface Water Intakes Located at River Mile 117.85l of the Kentucky River, Pool 7; Approximately 2,000 Feet Downstream of the Confluence of the Kentucky River and the Dix River	River	Permanent
Monroe	860426	Tompkinsville Water Works	Mill Creek Lake	Surface Water Intake Located at Mile 5.79 of Mill Creek in Tompkinsville City Lake (Plant Capacity 7/21/97 - 1.5 MGD)	Lake	Permanent
Montgomery	870298	Mount Sterling Water & Sewer System	Greenbriar Reservoir	Discharge Site	Reservoir	Other
Montgomery	870298	Mount Sterling Water & Sewer System	Slate Creek Reservoir	Withdrawal From Slate Creek Opposite Mile 35.64r (Reservoir), Montgomery Co	Reservoir	Permanent
Morgan	880452	West Liberty Water Works	Cave Run Lake	Surface Water Intake Located in Cave Run Lake at Mile 4.35 of the North Fork of the Licking River	Lake	Permanent
Morgan	880452	West Liberty Water Works	Licking River	Surface Water Withdrawal From River Mile 226.7 of the Licking River	River	Permanent

## APPENDIX 16: DRINKING WATER SOURCES

County	PWS ID	Owner	Source Name	Intake Location	Source Type	Availability
Muhlenberg	890071	Central City Municipal Water & Sewer System	Green River	Withdrawal From Green River Opposite Mile 85.4l, Muhlenberg County.	River	Permanent
Muhlenberg	890170	Greenville Utilities Commission	Luzerne Lake	Surface Water Intake Located in Luzerne Lake An Impoundment 1 Mile Northwest of the City of Greenville. Water Is Pumped From Luzerne Lake To Plant Lake To Water Treatment Plant. Country Club Lake Is A Backup Source To Luzerne Lake.	Lake	Permanent
Muhlenberg	890170	Greenville Utilities Commission	City		Lake	Other
Muhlenberg	890170	Greenville Utilities Commission	Country Club		Lake	Seasonal
Nelson	900017	Bardstown Municipal Water Department	Sympson Lake	Surface Water Intake Located in Lake Sympson, An Impoundment at Mile 1.0 of Buffalo Creek	Lake	Permanent
Nicholas	910065	Carlisle Water Department	Licking River	Surface Intake at Licking River Mile 107.8, Nicholas County	River	Permanent
Nicholas	910065	Carlisle Water Department	City Lake	Withdrawal From City Lake, Impoundment Approx. .25 Mi. Southwest of Carlisle in Nicholas County.	Lake	Permanent
Nicholas	910675	Western Fleming Water District	Licking River	W/D From Licking River Opposite Mile 100.54, Nicholas County.	River	Permanent
Ohio	920136	Fordsville Water Works	Fordsville Reservoir	Intake Located on the Fordsville Reservoir About .4 of A Mile South West of Fordsville Kentucky	Reservoir	Permanent
Ohio	920181	Hartford Municipal Water Works	Rough River	Intake Located at Mile 29.27r of the Rough River	River	Permanent
Ohio	920332	Ohio County Water District	Green River	Surface Water Withdrawal Located at River Mile 130.55 of the Green River	River	Permanent
Ohio	920373	Rockport Water Works	Green River	Surface Intake Located at Mile 94.9r of the Green River, Ohio County.	River	Permanent
Owen	940119	Elk Lake Water Company	Elk Lake Reservoir	Surface Water Intake Located at the Northern End of Elk Lake Dam.	Lake	Permanent
Owen	940337	Owenton City Water Works	Thomas Lake	Intake in Lower Thomas Lake, at River Mile 6.3 of North Fork of North Severn Creek, Owen Co	Lake	Permanent
Owen	940337	Owenton City Water Works	Severn Creek	Surface Intake in Severn Creek Opposite Mile 0.55l, Owen County	Creek	Permanent

## APPENDIX 16: DRINKING WATER SOURCES

County	PWS ID	Owner	Source Name	Intake Location	Source Type	Availability
Owsley	950036	Booneville Water And Sewer	South Fork Kentucky River	Surface Water Intake Located at Mile 12.6 of the South Fork of the Kentucky	River	Permanent
Pendleton	960051	Butler Water Works	Licking River	Withdrawal From Licking River Opposite Mile 35.01, Pendleton County.	River	Permanent
Pendleton	960126	Falmouth Water Department	Licking River	Withdrawal From Licking River Opposite Mile 52.091, Pendleton County.	River	Permanent
Perry	970184	Hazard Water Department	North Fork Kentucky River	Surface Water Intake Located at River Mile 361.23 of the North Fork of the Kentucky	River	Permanent
Pike	ELKHO RN	Elkhorn City Water Dept	Russell Fork Levisa Fork	Withdrawal From Russell Fork Opposite Mile 13.251, Pike County.	River	Permanent
Pike	980575	Mountain Water District	Russell Fork Levisa Fork	Surface Water Intake Located at Mile 3.85 of the Russell Fork of the Levi Sa Fork of the Big Sandy River	River	Permanent
Pike	980350	Pikeville Water Department	Levisa Fork/Big Sandy River	Surface Water Intake Located at Mile 117.8 of the Levisa Fork of the Big Sandy River	River	Permanent
Powell	990281	Beech Fork Water Commission	Beech Fork Reservoir	Surface Water Intake Located in Beech Fork Reservoir, An Impoundment of Beech Fork, A Tributary of Red River	Reservoir	Permanent
Powell	990281	Beech Fork Water Commission	Red River	Red River, River Mile 33.5	River	Permanent
Pulaski	1000050	Burnside Municipal Water Works	Lake Cumberland	Surface Water Intake Located in Lake Cumberland at River Mile 517.6 of the Cumberland River	Lake	Permanent
Pulaski	1000403	Somerset Utilities	Lake Cumberland	Surface Water Intake Located at Mile 513.6 of the Cumberland River (Lake) Cumberland	Lake	Permanent
Robertson	1010297	Mount Olivet Water Department	Licking River		River	Emergency
Rockcastle	1020229	City Of Mount Vernon	Lake Linville	Surface Water Intake Located in An Impoundment at Mile 3.0 of Renfro Cree	Lake	Permanent
Rowan	1030480	Morehead State University	Evans Branch Reservoir	Withdrawal From Evans Branch at Mile 0.7 (Evans Branch Impoundment), Rowan County.	Reservoir	Permanent
Rowan	1030480	Morehead State University	Triplet Creek	Withdrawal From Triplets Creek Opposite Mile 13.78r, Rowan County.	Creek	Permanent
Russell	1040210	Jamestown Utilities	Lake Cumberland	Surface Water Intake Located at Stream Mile 3.75 of the Greasy Creek Bran Ch of Lake Cumberland	Lake	Permanent

### APPENDIX 16: DRINKING WATER SOURCES

County	PWS ID	Owner	Source Name	Intake Location	Source Type	Availability
Scott	1050157	Georgetown Municipal Water & Sewer Service	Royal Spring	Mile 0.61 of Royal Springs, A Tributary of North Fork of Elkhorn Creek	Spring	Permanent
Scott	1050157	Georgetown Municipal Water & Sewer Service	North Fork Elkhorn Creek	Withdrawal From North Elkhorn Creek Opposite Mile 50.91, Scott County.	Creek	Emergency
Shelby	1060394	Shelbyville Municipal Water And Sewer Commission	Guist Creek Lake	Surface Water Intake Located in Guist Creek Lake, An Impoundment at Mile 27.51 of Guist Creek	Lake	Permanent
Simpson	1070144	Franklin Water Works	Drakes Creek	Intake Located on West Fork of Drake's Creek 0.5 Mile Downstream of Kentucky Hwy 73/100/265 Bridge, East of Franklin, Ky.	Creek	Permanent
Taylor	1090060	Campbellsville Municipal Water & Sewer System	Green River Reservoir	Surface Intake in Green River Reservoir (Mile 5.8r of Robinson Creek)	Reservoir	Permanent
Taylor	1090060	Campbellsville Municipal Water & Sewer System	Campbellsville Reservoir	Withdrawal from Trace Fork Approximately at River Mile 1.1(r) (City Reservoir)	Reservoir	Emergency
Todd	1100171	Guthrie Water Works	Merriweather Spring	Withdrawal From Merriweather Spring, Mile 0.11 of Tributary. To Spring Ck (Mile 14.671), Todd County.	Spring	Permanent
Todd	1100944	Todd County Water District	Settles Lake	Surface Water Intake Located in Settles Lake (1-A) an Impoundment of the East Fork of the Pond River at River Mile 96.95, Todd County	Lake	Permanent
Trigg	1110019	Barkley Lake Water District	Barkley Lake	Surface Water Intake Located in Hopson Creek Bay Opposite Mile 1.0r of Barkley Lake	Lake	Permanent
Trigg	1110054	Cadiz Municipal Water Company	Cadiz Spring	Spring Located Approx. 1000' North East of the City Water Treatment Plant, which is Located at River Mile 18.4 of Little River, Off of Route 139	Spring	Permanent
Union	1130293	Morganfield Water Works	Ohio River	Intake on South Bank Ohio River at Mile 840.0 Bp, Union County	River	Permanent
Union	1130422	Sturgis Water Works	Ohio River	Surface Intake Located Left Bank of Ohio River at Mi. 871.4 Bp, Union Co.	River	Permanent
Warren	1140038	Bowling Green Municipal Utilities	Barren River	Surface Water Intake Located at Mile 37.82 of the Barren River	River	Permanent



### APPENDIX 16: DRINKING WATER SOURCES

County	PWS ID	Owner	Source Name	Intake Location	Source Type	Availability
Washington	1150415	Springfield Water Works	Willis burg Lake	Surface Intake Located in Willisburg Lake, An Impoundment at Mile 4.2 of Long Lick Creek	Lake	Permanent
Washington	1150415	Springfield Water Works	Allen Branch Reservoir	Surface Intake Located in the Spring/Allen Branch Reservoir, An Impoundment at Mile 1.3 of Allen Branch	Reservoir	Permanent
Washington	1150415	Springfield Water Works	City Lake	Surface Water Intake Located in City Lake, An Impoundment at Mile 4.86 of Road Run	Reservoir	Permanent
Wayne	1160291	Monticello Utility Commission	Lake Cumberland	Surface Intake Located in Lake Cumberland, at Mile 502.15 of the Cumberland River	Lake	Permanent
Webster	510510	Henderson Water Utilities South	Green River	River Mile 177.8	River	Permanent
Webster	1170361	Providence Water Works	New City Lake	Surface Intake Located in the New Providence City Lake, An Impoundment of A Tributary To Owens Creek	Lake	Permanent
Webster	1170995	Webster County Water District	Green River		River	Permanent
Whitley	1180471	City Of Williamsburg	Cumberland River	Withdrawal From the Cumberland River Opposite Mile 584.301, Whitley County	River	Permanent
Whitley	1182561	Cumberland Falls State Park	Cumberland River	Surface Water Intake Located at Mile 562.5 of the Cumberland River	River	Permanent
Wolfe	1190061	Campton Water Plant	Campton Lake	Surface Water Intake Located in Campton Lake, An Impoundment of Hiram Bra	Lake	Permanent
Woodford	1200439	Versailles Municipal Water	Kentucky River Pool 5	Surface Water Intake Located at Mile 85.27 of the Kentucky River (Pool 5)	River	Permanent
	1101005	Logan/Todd Regional Water Commission	Cumberland River	Intake Located on Cumberland River in Tennessee	Lake	Permanent

## **Appendix 17. Consent Release Form**



KENTUCKY TRANSPORTATION CABINET  
Division of Operations

TC 71-14  
Rev. 11-94

*CONSENT AND RELEASE*

COUNTY: \_\_\_\_\_ PROJECT NO: \_\_\_\_\_

ROAD NAME: \_\_\_\_\_

WHEREAS, the Transportation Cabinet, Commonwealth of Kentucky, finds it necessary in order to protect Highway No. \_\_\_\_\_ to do the following work: \_\_\_\_\_

\_\_\_\_\_  
\_\_\_\_\_  
\_\_\_\_\_

on the land of \_\_\_\_\_  
County, Kentucky \_\_\_\_\_

NOW, THEREFORE, in consideration of the above and the incidental benefits accruing to the property, I hereby consent and agree that the Transportation Cabinet may come upon the above property and do the work as set out above, and do further agree that I will assert no claim for damages against the Transportation Cabinet by reason of said work, but by these presents shall be forever barred.

This, the \_\_\_\_\_ day of \_\_\_\_\_, 19 \_\_\_\_\_.

\_\_\_\_\_  
\_\_\_\_\_

WITNESS

\_\_\_\_\_  
*Projects Engineer or Maintenance Foreman*

APPROVED

\_\_\_\_\_  
*Chief District Engineer*

## **Appendix 18. In-Stream Best Management Practices Drawings**



## **Appendix 19. Bioengineering Standard Drawings**





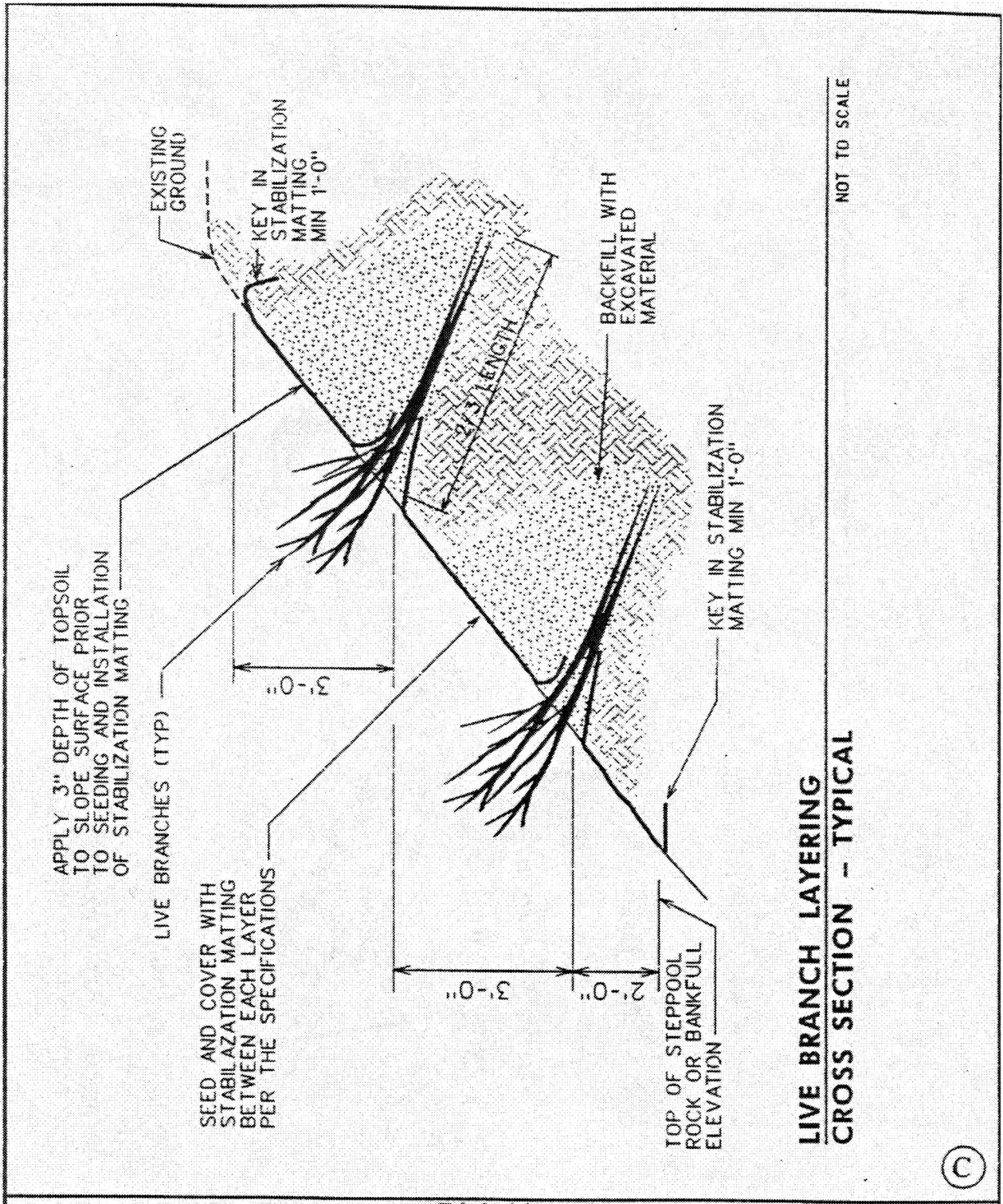

**Biohabitats, Inc.**  
 15 West Aylesbury Road  
 Timonium, Maryland 21093  
 Phone: 410-357-3659  
 Fax: 410-583-5678

· Fostering Ecological Stewardship ·

DATE CREATED: 1/98

Live Branch Layering— cross section

BE-0001

(C)

LIVE STAKE

DEAD STAKE

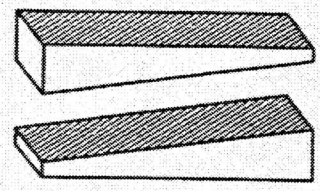
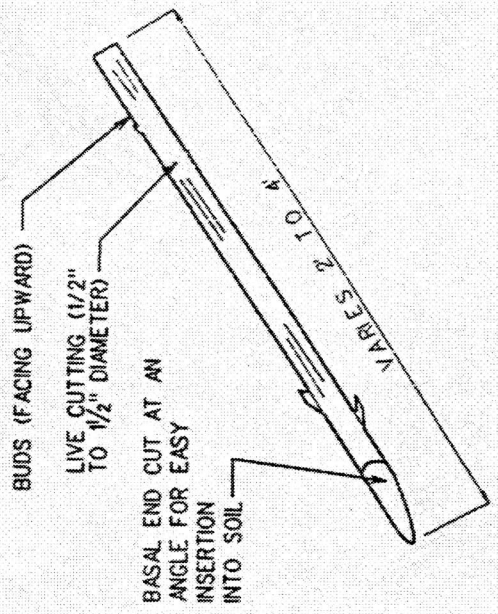

SAW A 2" x 4" DIAGONALLY TO PRODUCE TWO DEAD STOUT STAKES

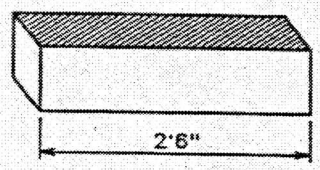

TYPICAL LIVE STAKE & DEAD STOUT STAKE

NOT TO SCALE

©



**Biohabitats, Inc.**  
 15 West Aylesbury Road  
 Timonium, Maryland 21093  
 Phone: 410-337-3659  
 Fax: 410-583-5678  
 Fostering Ecological Stewardship

DATE CREATED: 1/99

Live Stake & Dead Stake

BE-0005

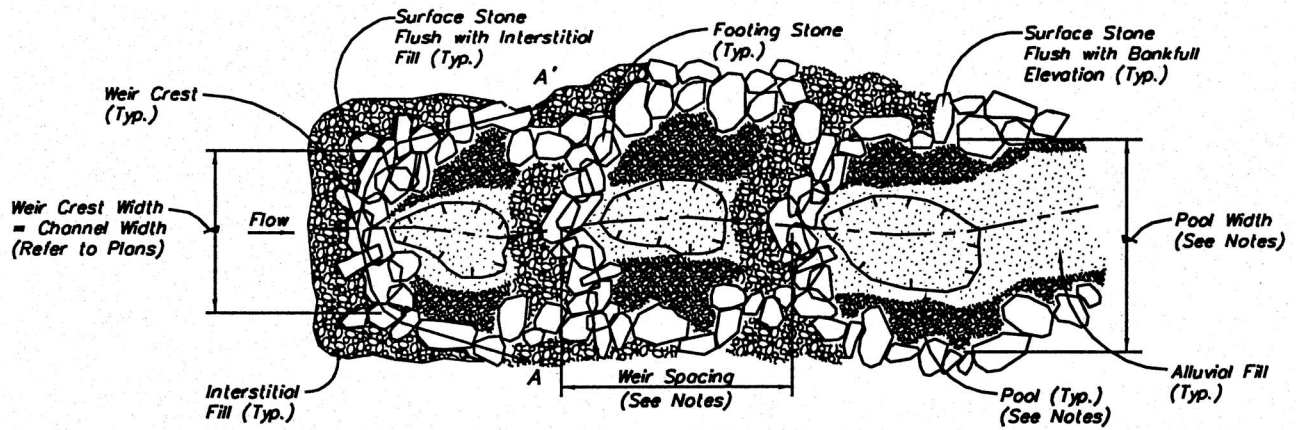

PLAN

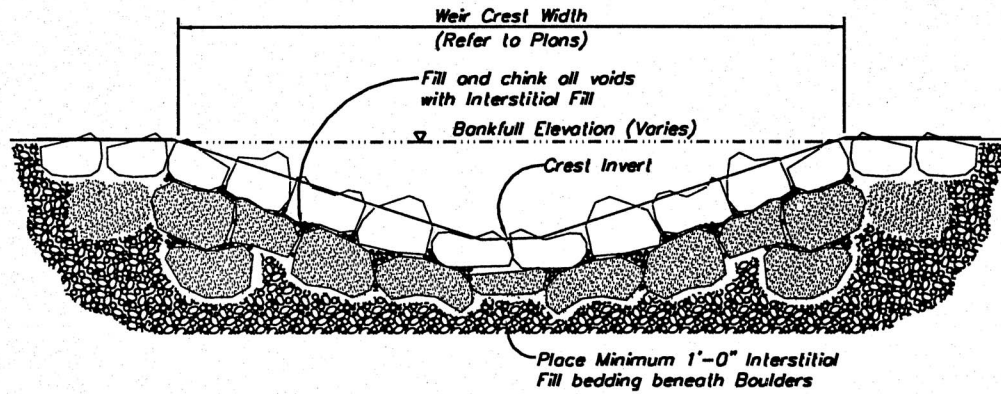

SECTION A-A'

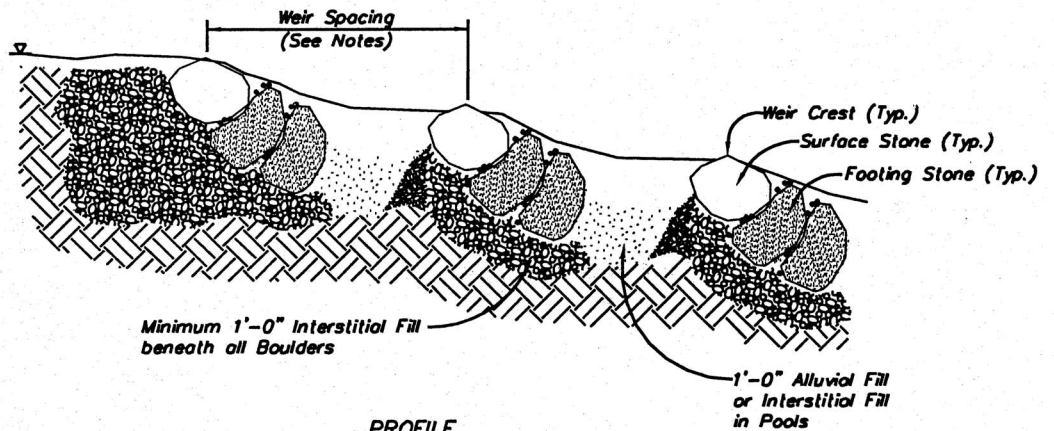

PROFILE

DETAIL - STEP POOL CHANNEL TYPE A  
NOT TO SCALE

**NOTES:**

1. Pool Depth = 1.5 to 2.5 x Crest Depth.
2. Weir Crest Width = Local Channel Bankfull Width.
3. Weir Spacing varies, use random lengths 1 to 4 x Weir Crest Width.
4. Not more than five consecutive pools shall have the same finished dimensions.
5. Refer to longitudinal Profile for Weir Crest elevations.

**DETAIL  
STEP POOL**



FULLER  
MOSSBARGER  
SCOTT AND MAY  
ENGINEERS, INC.

1901 Nelson Miller Parkway  
Louisville, Kentucky  
40223-2177  
502-322-3900

LEXINGTON LOUISVILLE CINCINNATI COLUMBUS ST. LOUIS

StepPools.Dgn	DRAWN BY	R.R.P.	DATE	January, 2005	REVISED	
	CHECKED BY	A.K.	PROJECT NO.	LV2004033	1.	3.
	CHECKED BY	J.G.A.	SCALE	Not To Scale	2.	4.

SHEET

1 of 3

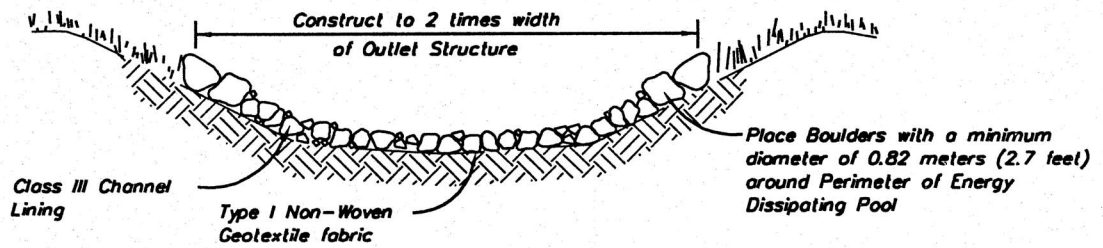

**DETAIL - ENERGY DISSIPATING POOL**  
 NOT TO SCALE

**DETAIL  
ENERGY DISSIPATION POOL**



FULLER  
 MOSSBARGER  
 SCOTT AND MAY  
 ENGINEERS, INC.  
  
 1409 N. Forbes Rd.  
 Lexington, Kentucky  
 40511-2650  
 606-423-3000

Eng-DissPool.dgn

<b>DRAWN BY</b> R.R.P.	<b>DATE</b> January, 2005	<b>REVISED</b>		<b>SHEET</b>  <b>3 of 3</b>
<b>CHECKED BY</b> A.K.	<b>PROJECT NO.</b> LV2004033	1.	3.	
<b>CHECKED BY</b> J.G.A.	<b>SCALE</b> Not To Scale	2.	4.	

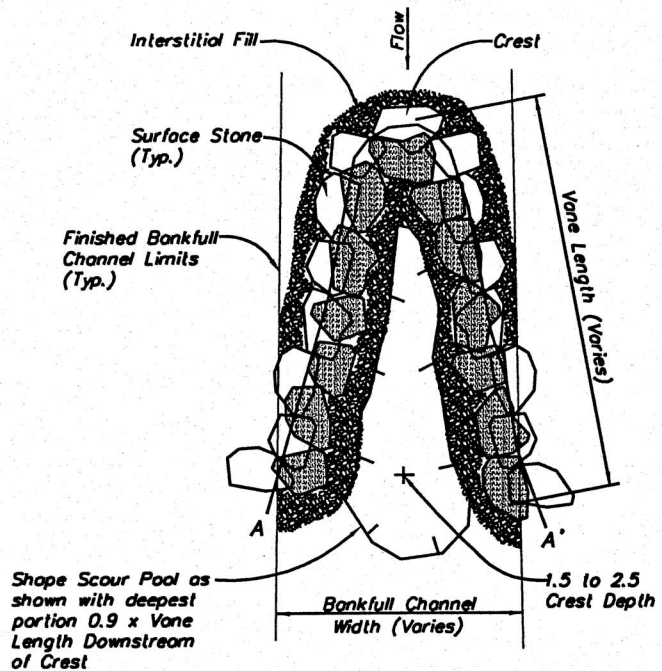

- NOTES:**
1. Crest Depth = 0.9 x Local Thalweg Depth.
  2. Minimum Boulder size varies.

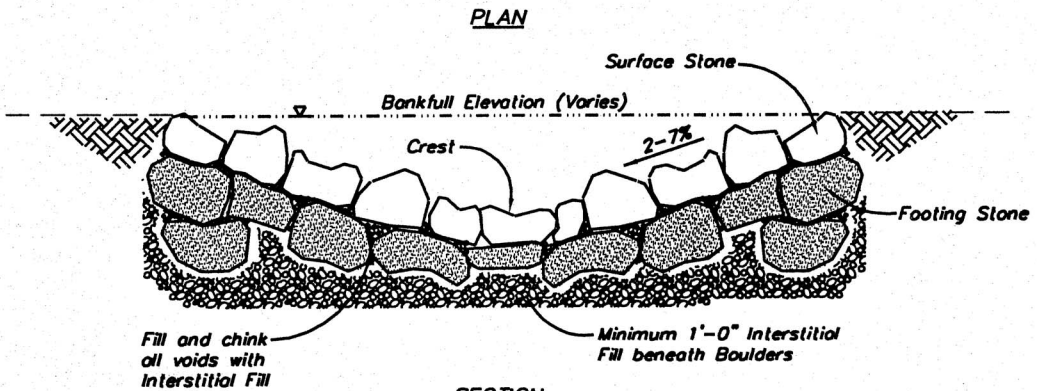

**SECTION**

**DETAIL - CROSS-VANE**  
NOT TO SCALE

<b>DETAIL CROSS VANE</b>			
 <p><b>MSM</b> <b>ENGINEERS</b></p> <p>LEXINGTON LOUISVILLE CINCINNATI COLUMBUS ST. LOUIS</p>			<p>FULLER MOSSBARGER SCOTT AND MAY ENGINEERS, INC.</p> <p>190 Nelson Miller Parkway Louisville Kentucky 40223-2177 502-225-5800</p>
CrossVane.Dgn	<b>DRAWN BY</b> R.R.P.	<b>DATE</b> January, 2005	<b>REVISED</b>
	<b>CHECKED BY</b> A.K.	<b>PROJECT NO.</b> LV2004033	1. 3.
	<b>CHECKED BY</b> J.G.A.	<b>SCALE</b> Not To Scale	2. 4.
			<b>SHEET</b> <b>2 of 3</b>

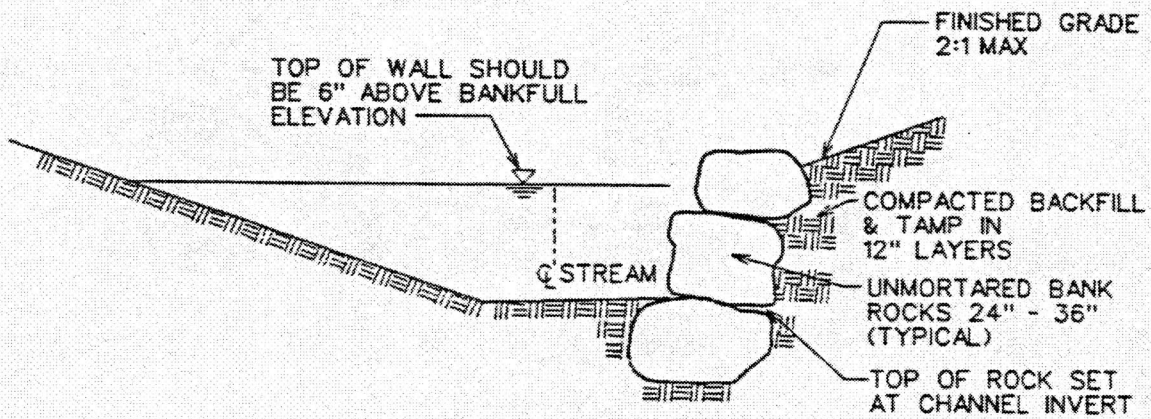

**ROCK BANK STABILIZATION SECTION**

NOT TO SCALE

©



**Biohabitats, Inc.**  
 15 West Aylesbury Road  
 Timonium, Maryland 21093  
 Phone: 410-337-3659  
 Fax: 410-583-5678  
 • Fostering Ecological Stewardship

DATE CREATED: 1/98

Rock Bank Stabilization

BE-0019

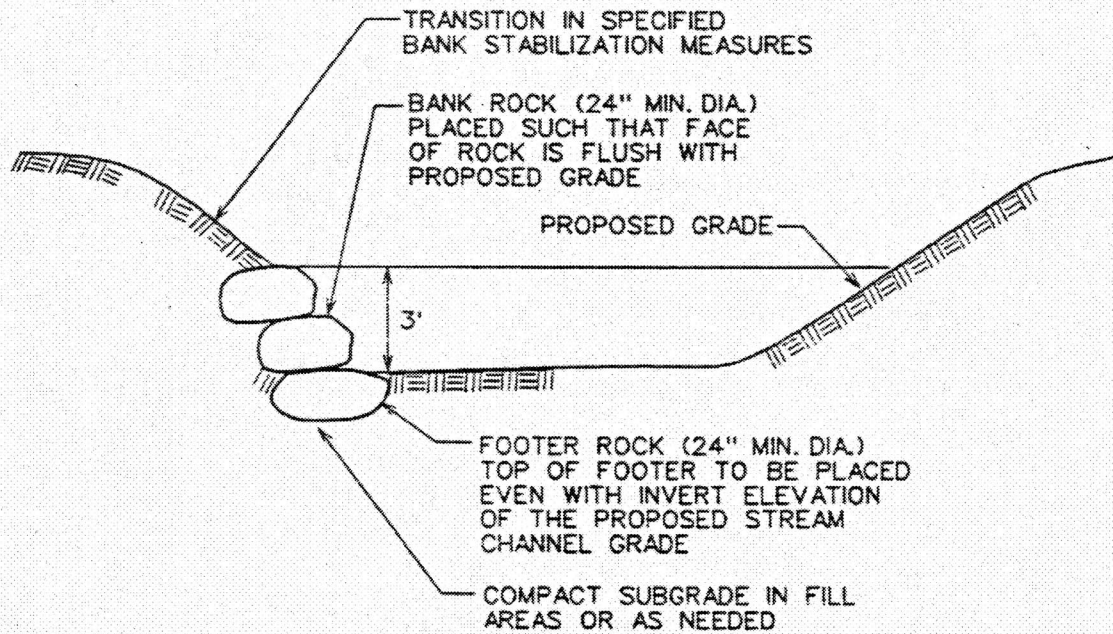

**ROCK TOE PROTECTION  
CROSS SECTION**

NOT TO SCALE



**Biohabitats, Inc.**

15 West Aylesbury Road  
Timonium, Maryland 21093  
Phone: 410-337-3659  
Fax: 410-583-5678

Fostering Ecological Stewardship

DATE CREATED: 7/98

Rock Toe Protection – cross section

BE-0020

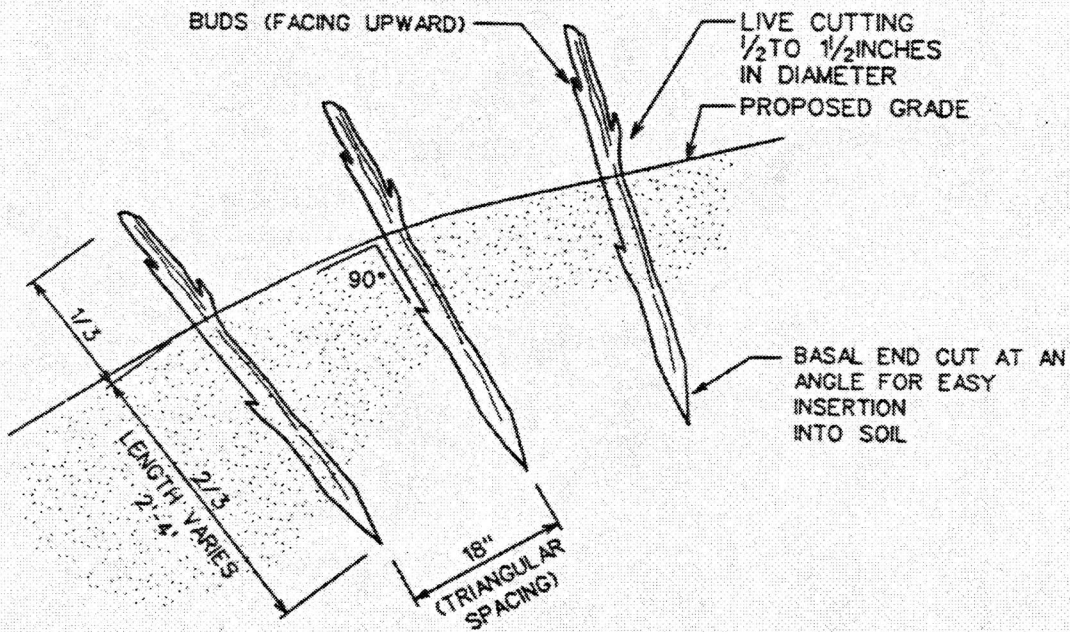

**LIVE STAKE INSTALLATION  
CROSS SECTION- TYPICAL**

NOT TO SCALE

©



**Biohabitats, Inc.**  
 15 West Aylesbury Road  
 Timonium, Maryland 21093  
 Phone: 410-337-3659  
 Fax: 410-583-5678  
 Fostering Ecological Stewardship

DATE CREATED: 9/99

Live Stake Installation – cross section

BE-0021



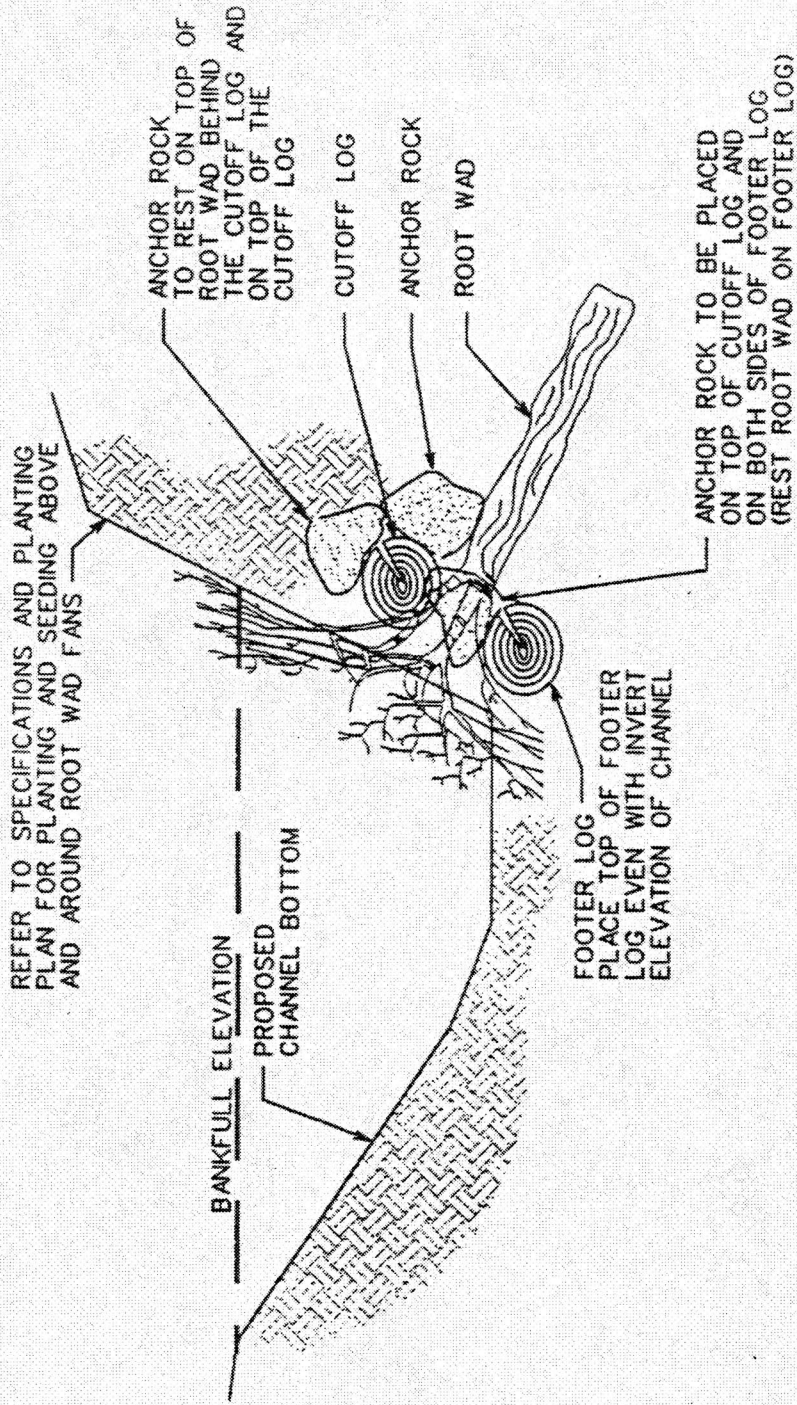

**ROOT WAD- REVETMENT  
CROSS SECTION- TYPICAL**

NOT TO SCALE



**Biohabitats, Inc.**  
 15 West Aylesbury Road  
 Timonium, Maryland 21093  
 Phone: 410-337-3659  
 Fax: 410-583-5678  
 Fostering Ecological Stewardship

DATE CREATED: 9/99

Root Wad – cross section

BE-0022

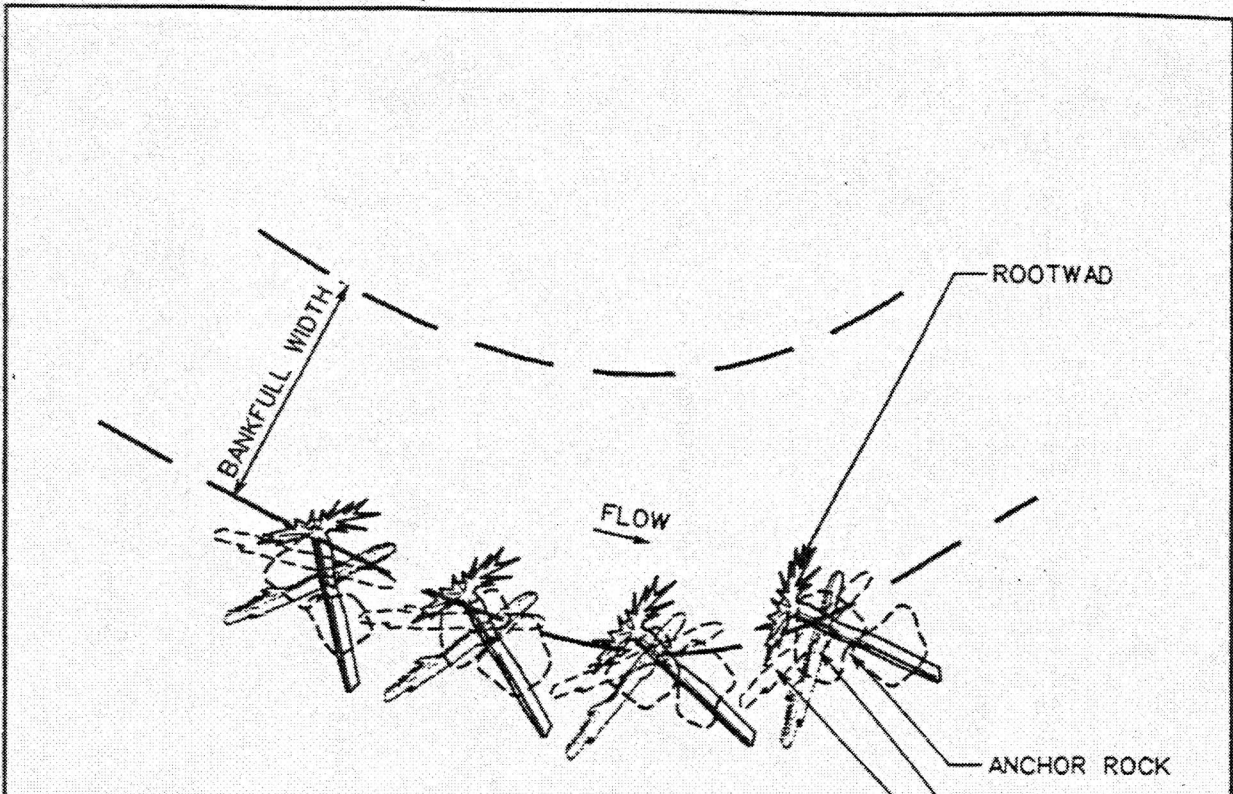

WHEN BACKFILLING OVER AND AROUND FOOTER LOGS, ROOT WAD LOGS, AND CUTOFF LOGS, PACK ROCK AND SOIL IN BETWEEN ALL VOIDS TO FIRMLY SECURE ALL COMPONENTS INCLUDING JOINTS, CONNECTIONS AND GAPS.

**ROOT WAD REVETMENT  
PLAN VIEW- TYPICAL**

NOT TO SCALE

©



**Biohabitats, Inc.**  
 15 West Aylesbury Road  
 Timonium, Maryland 21093  
 Phone: 410-337-3659  
 Fax: 410-583-5678  
 Fostering Ecological Stewardship

DATE CREATED: 7/98

ROOTWADS REVETMENT- plan view

BE-0026